

Cree® XLamp® XH-B LED

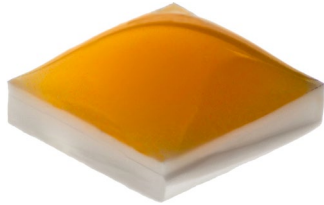

PRODUCT DESCRIPTION

Unlike common plastic packages, XLamp® XH LEDs use a ceramic package to deliver the unique combination of high performance and reliability not available elsewhere in mid-power LEDs. The ceramic-based XH LEDs are designed to deliver the long L70 lifetimes of Cree's other high-power LEDs, such as XP or XT LEDs, as well as industry-leading LED efficacy levels.

Optimized for fluorescent replacement lighting applications, such as troffers and panel lights, where high efficacy, long lifetime and smooth appearance are critical, the XH LEDs allow lighting manufacturers to offer products that meet the lifetime expectations of LED technology.

FEATURES

- Package size: 3.0 X 3.0 mm
- Available in white, 70-minimum CRI cool white, 80-minimum CRI white and 85- and 90-minimum CRI warm white
- 175 mA maximum drive current
- Viewing angle: 130°
- Reflow solderable - JEDEC J-STD-020C compatible
- Unlimited floor life at $\leq 30\text{ }^{\circ}\text{C}/85\%\text{ RH}$
- RoHS and REACH compliant
- UL® recognized component (E349212)



TABLE OF CONTENTS

Characteristics	2
Flux Characteristics	3
Relative Spectral Power Distribution	4
Relative Flux vs. Junction Temperature	4
Electrical Characteristics	5
Relative Flux vs. Current	5
Typical Spatial Distribution	6
Thermal Design	6
Reflow Soldering Characteristics	7
Notes	8
Mechanical Dimensions	9
Tape and Reel	10
Packaging	11

CHARACTERISTICS

Characteristics	Unit	Minimum	Typical	Maximum
Thermal resistance, junction to solder point	°C/W		45	
Viewing angle (FWHM)	degrees		130	
Temperature coefficient of voltage	mV/°C		-2	
ESD withstand voltage (HBM per Mil-Std-883D)	V			8000
DC forward current	mA			175
Reverse voltage	V			-5
Forward voltage (@ 65 mA, 25 °C)	V		3.1	3.6
LED junction temperature	°C			150

FLUX CHARACTERISTICS ($T_j = 25\text{ }^\circ\text{C}$)

The following table provides several base order codes for XLamp XH-B LEDs. It is important to note that the base order codes listed here are a subset of the total available order codes for the product family. For more order codes, as well as a complete description of the order-code nomenclature, please consult the XLamp XH LED Family Binning and Labeling document.

Color	CCT Range		Minimum Luminous Flux @ 65 mA		Calculated Minimum Luminous Flux (lm)*	Order Code
	Minimum	Maximum	Group	Flux (lm)	125 mA	
Cool White	5000 K	8300 K	J3	26.8	46.0	XHBAWT-00-0000-00000LX51
Neutral White	3700 K	5000 K	J2	23.5	40.4	XHBAWT-00-0000-00000LWE5
Warm White	2600 K	3700 K	J2	23.5	40.4	XHBAWT-00-0000-00000LWE7
70-CRI White	5000 K	8300 K	J3	26.8	46.0	XHBAWT-00-0000-00000BX51
	3700 K	5000 K	J2	23.5	40.4	XHBAWT-00-0000-00000BWE5
	2600 K	3700 K	J2	23.5	40.4	XHBAWT-00-0000-00000BWE7
80-CRI White	5000 K	8300 K	J3	26.8	46.0	XHBAWT-00-0000-00000HX51
	3700 K	5000 K	J2	23.5	40.4	XHBAWT-00-0000-00000HWE5
	2600 K	3700 K	J2	23.5	40.4	XHBAWT-00-0000-00000HWE7
85-CRI White	2600 K	3200 K	H0	18.1	31.1	XHBAWT-00-0000-00000PVE7
90-CRI White	2600 K	3200 K	H0	18.1	31.1	XHBAWT-00-0000-00000UVE7

Notes:

- Cree maintains a tolerance of $\pm 7\%$ on flux and power measurements, ± 0.005 on chromaticity (CCx, CCy) measurements and ± 2 on CRI measurements. See the Measurements section (page 8).
 - Typical CRI for Neutral White, 3700 K - 5000 K CCT is 75.
 - Typical CRI for Warm White, 2600 K - 3700 K CCT is 80.
 - Minimum CRI for 70-CRI Minimum Cool White is 70.
 - Minimum CRI for 80-CRI Minimum White is 80.
 - Minimum CRI for 85-CRI Minimum White is 85.
 - Minimum CRI for 90-CRI Minimum White is 90.
- * Calculated flux values at 125 mA are for reference only.

RELATIVE SPECTRAL POWER DISTRIBUTION

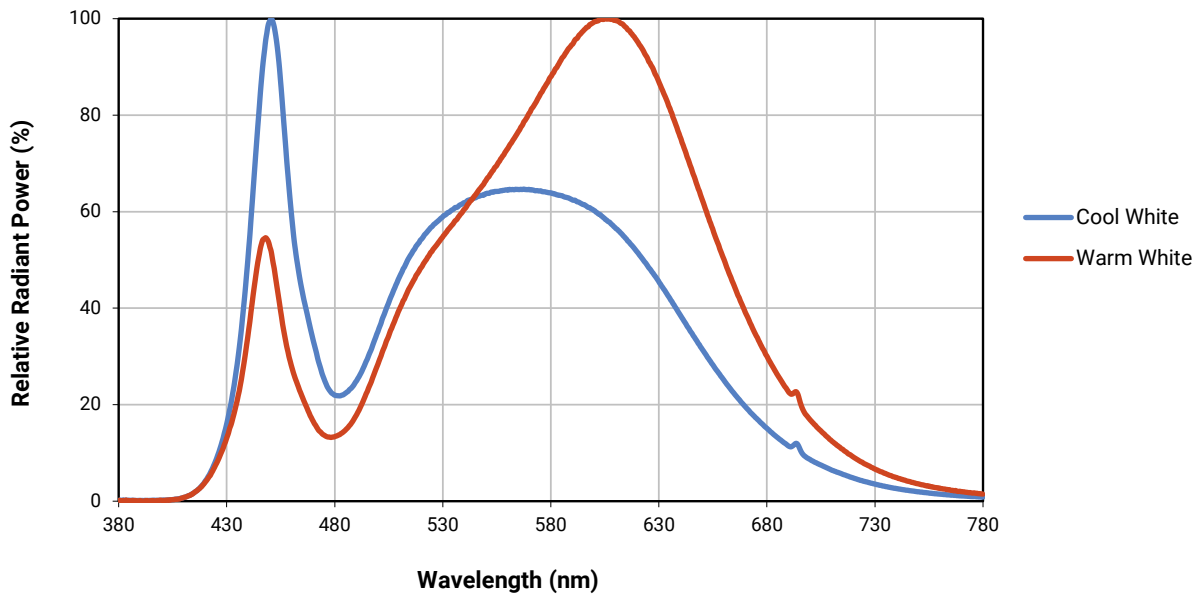

RELATIVE FLUX VS. JUNCTION TEMPERATURE ($I_F = 65 \text{ mA}$)

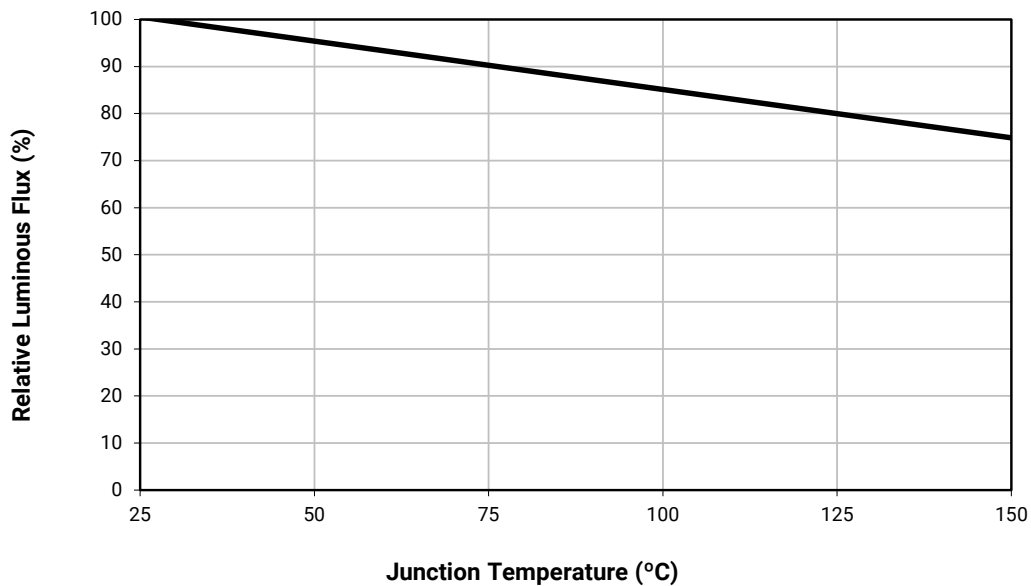

ELECTRICAL CHARACTERISTICS ($T_j = 25\text{ }^\circ\text{C}$)

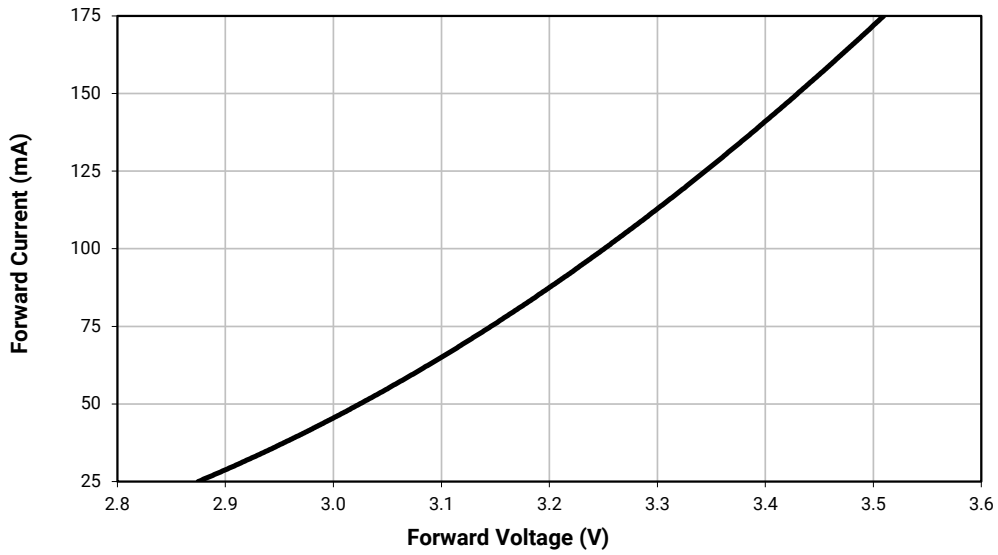

RELATIVE FLUX VS. CURRENT ($T_j = 25\text{ }^\circ\text{C}$)

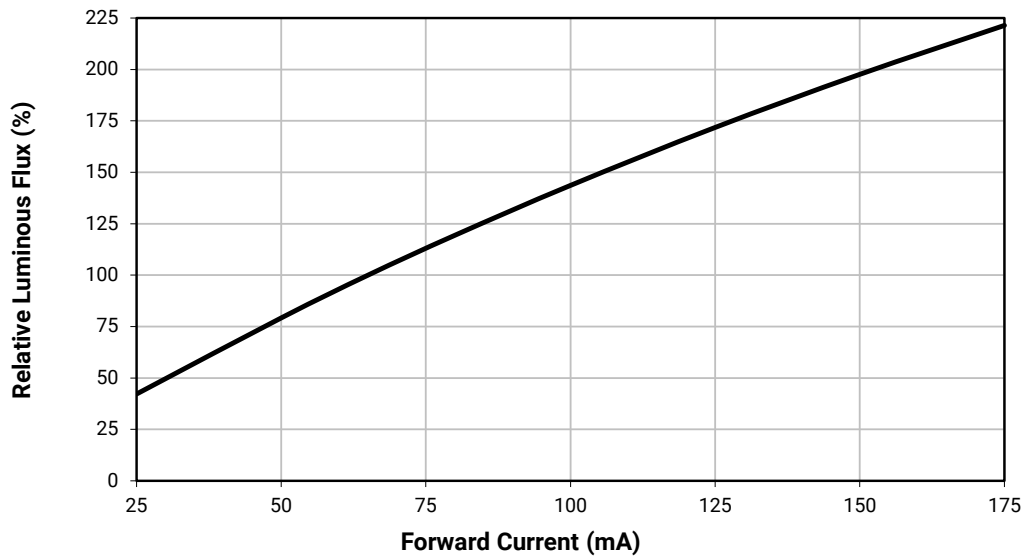

TYPICAL SPATIAL DISTRIBUTION

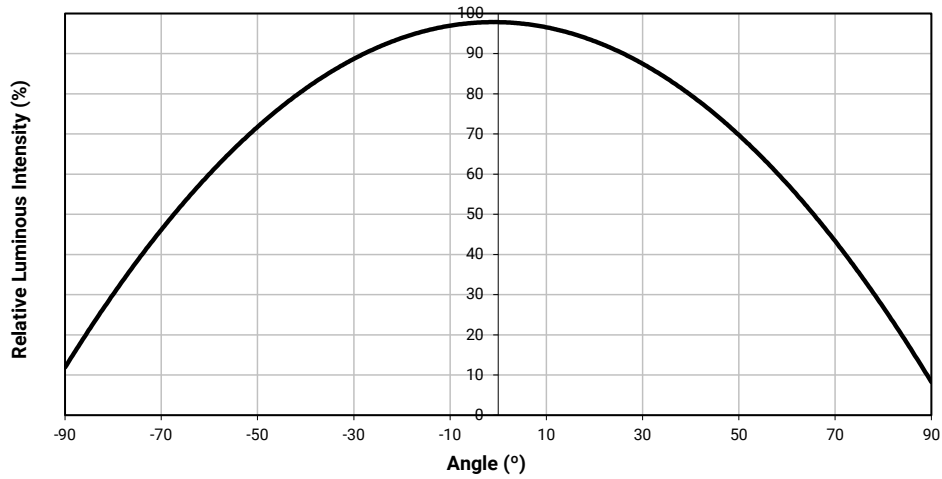

THERMAL DESIGN

The maximum forward current is determined by the thermal resistance between the LED junction and ambient. It is crucial for the end product to be designed in a manner that minimizes the thermal resistance from the solder point to ambient in order to optimize lamp life and optical characteristics.

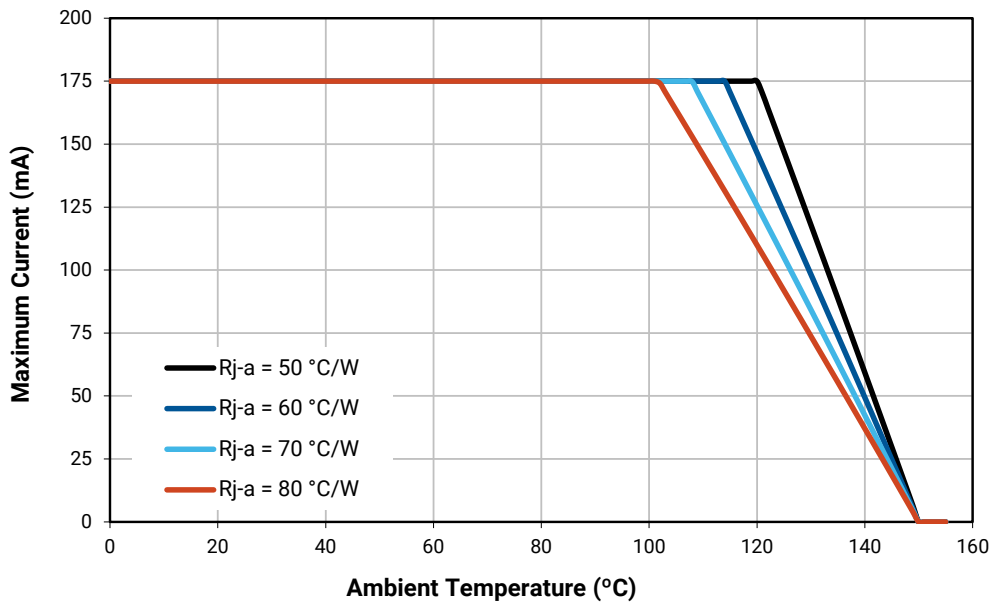

REFLOW SOLDERING CHARACTERISTICS

In testing, Cree has found XLamp XH-B LEDs to be compatible with JEDEC J-STD-020C, using the parameters listed below. As a general guideline, Cree recommends that users follow the recommended soldering profile provided by the manufacturer of the solder paste used.

Note that this general guideline may not apply to all PCB designs and configurations of reflow soldering equipment.

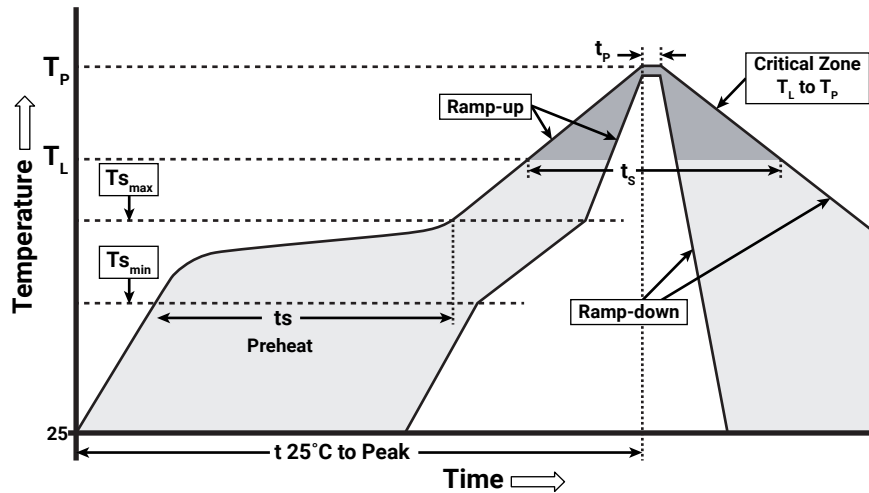

IPC/JEDEC J-STD-020C

Profile Feature	Lead-Free Solder
Average Ramp-Up Rate ($T_{s_{max}}$ to T_P)	1.2 °C/second
Preheat: Temperature Min ($T_{s_{min}}$)	120 °C
Preheat: Temperature Max ($T_{s_{max}}$)	170 °C
Preheat: Time ($t_{s_{min}}$ to $t_{s_{max}}$)	65-150 seconds
Time Maintained Above: Temperature (T_L)	217 °C
Time Maintained Above: Time (t_L)	45-90 seconds
Peak/Classification Temperature (T_P)	235 - 245 °C
Time Within 5 °C of Actual Peak Temperature (t_p)	20-40 seconds
Ramp-Down Rate	1 - 6 °C/second
Time 25 °C to Peak Temperature	4 minutes max.

Note: All temperatures refer to topside of the package, measured on the package body surface.

NOTES

Measurements

The luminous flux, radiant power, chromaticity, forward voltage and CRI measurements in this document are binning specifications only and solely represent product measurements as of the date of shipment. These measurements will change over time based on a number of factors that are not within Cree's control and are not intended or provided as operational specifications for the products. Calculated values are provided for informational purposes only and are not intended as specifications.

Pre-Release Qualification Testing

Please read the [LED Reliability Overview](#) for details of the qualification process Cree applies to ensure long-term reliability for XLamp LEDs and details of Cree's pre-release qualification testing for XLamp LEDs.

Lumen Maintenance

Cree now uses standardized IES LM-80-08 and TM-21-11 methods for collecting long-term data and extrapolating LED lumen maintenance. For information on the specific LM-80 data sets available for this LED, refer to the public [LM-80 results document](#).

Please read the [Long-Term Lumen Maintenance application note](#) for more details on Cree's lumen maintenance testing and forecasting. Please read the [Thermal Management application note](#) for details on how thermal design, ambient temperature, and drive current affect the LED junction temperature.

Moisture Sensitivity

Cree recommends keeping XLamp LEDs in the provided, resealable moisture-barrier packaging (MBP) until immediately prior to soldering. Unopened MBPs that contain XLamp LEDs do not need special storage for moisture sensitivity.

Once the MBP is opened, XLamp XH-B LEDs may be stored as MSL 1 per JEDEC J-STD-033, meaning they have unlimited floor life in conditions of ≤ 30 °C/85% relative humidity (RH). Regardless of storage condition, Cree recommends sealing any unsoldered LEDs in the original MBP.

RoHS Compliance

The levels of RoHS restricted materials in this product are below the maximum concentration values (also referred to as the threshold limits) permitted for such substances, or are used in an exempted application, in accordance with EU Directive 2011/65/EC (RoHS2), as implemented January 2, 2013. RoHS Declarations for this product can be obtained from your Cree representative or from the Product Documentation sections of www.cree.com.

REACH Compliance

REACH substances of very high concern (SVHCs) information is available for this product. Since the European Chemical Agency (ECHA) has published notice of their intent to frequently revise the SVHC listing for the foreseeable future, please contact a Cree representative to insure you get the most up-to-date REACH SVHC Declaration. REACH banned substance information (REACH Article 67) is also available upon request.

NOTES - CONTINUED

UL® Recognized Component

Level 4 enclosure consideration. The LED package or a portion thereof has been investigated as a fire and electrical enclosure per ANSI/UL 8750.

Vision Advisory

WARNING: Do not look at exposed lamp in operation. Eye injury can result. For more information about LEDs and eye safety, please refer to the [LED Eye Safety application note](#).

MECHANICAL DIMENSIONS

All dimensions are $\pm .13$ mm unless otherwise indicated.

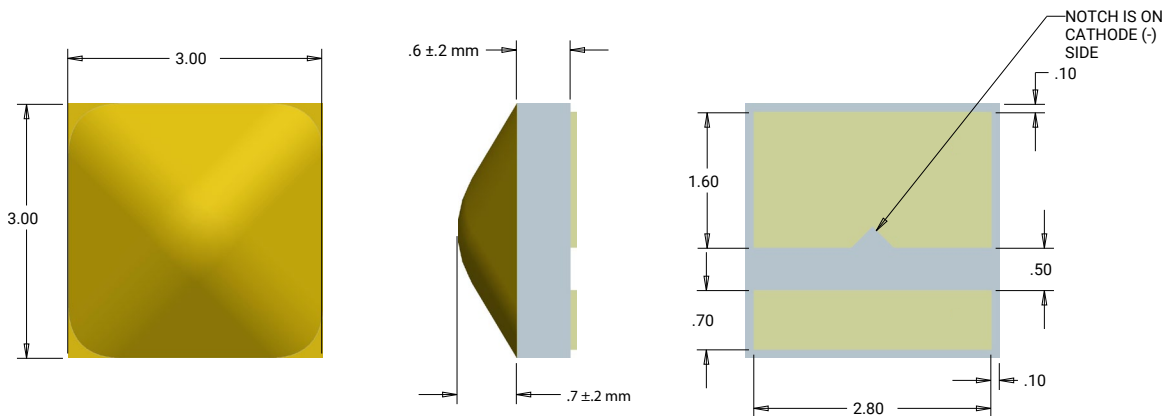

Top View

Side View

Bottom View

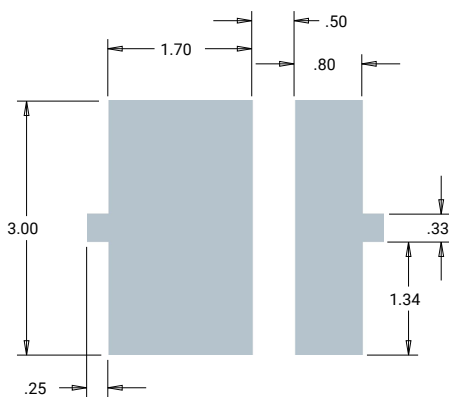

Recommended PC Board Solder Pad

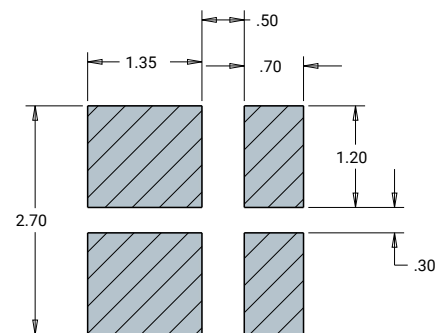

**Recommended Metal Stencil Mask
(Hatched Area is Open)**

TAPE AND REEL

All Cree carrier tapes conform to EIA-481D, Automated Component Handling Systems Standard.
 All dimensions are ±.13 mm unless otherwise indicated.

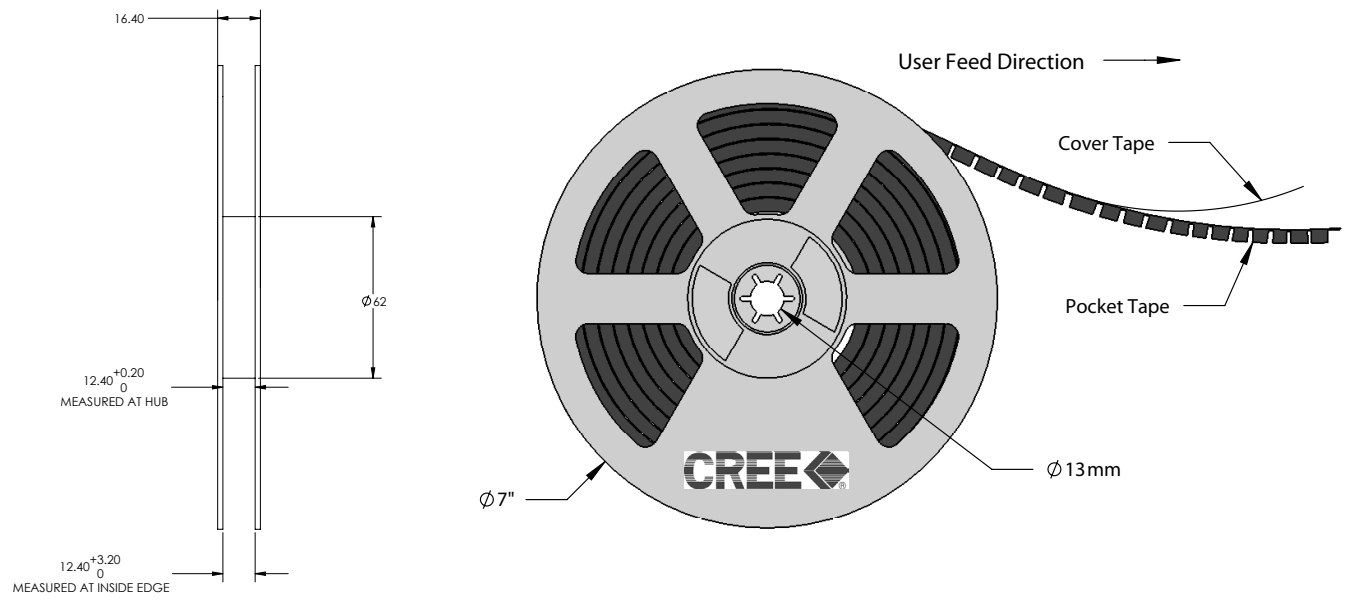
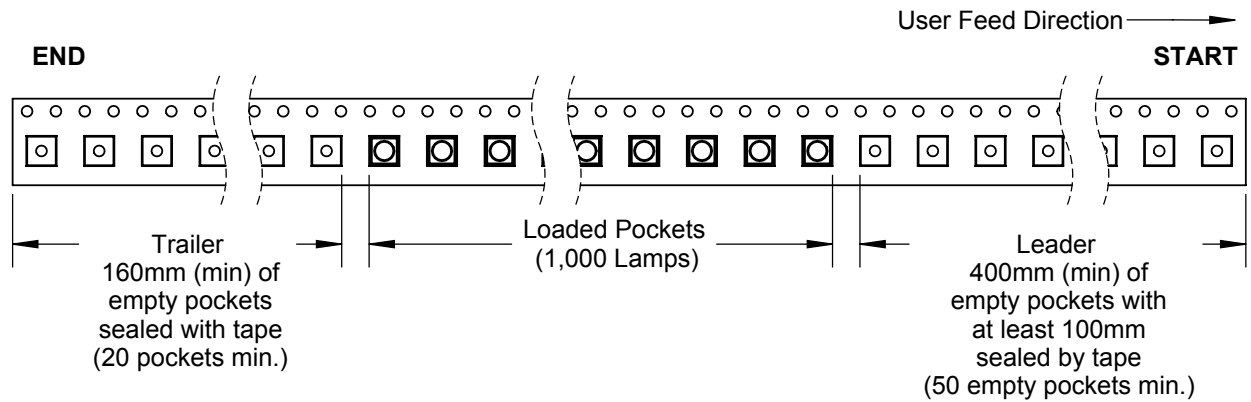
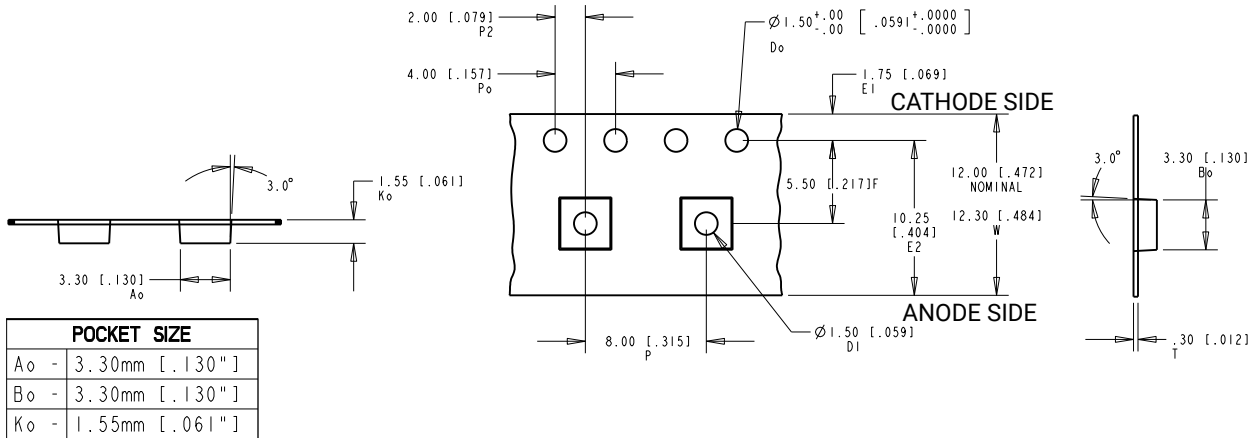

PACKAGING

The diagrams below show the packaging and labels Cree uses to ship XLamp XH-B LEDs. XLamp XH-B LEDs are shipped in tape loaded on a reel. Each box contains only one reel in a moisture barrier bag.

Unpackaged Reel

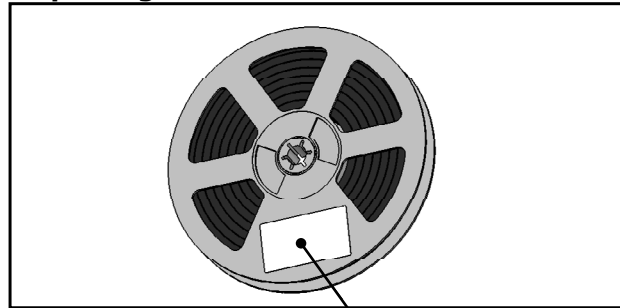

Label with Cree Bin Code, Quantity, Reel ID

Packaged Reel

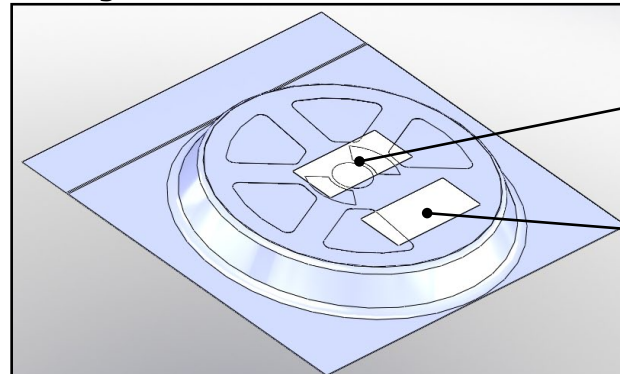

Label with Cree Order Code, Quantity, Reel ID, PO #

Label with Cree Bin Code, Quantity, Reel ID

Boxed Reel

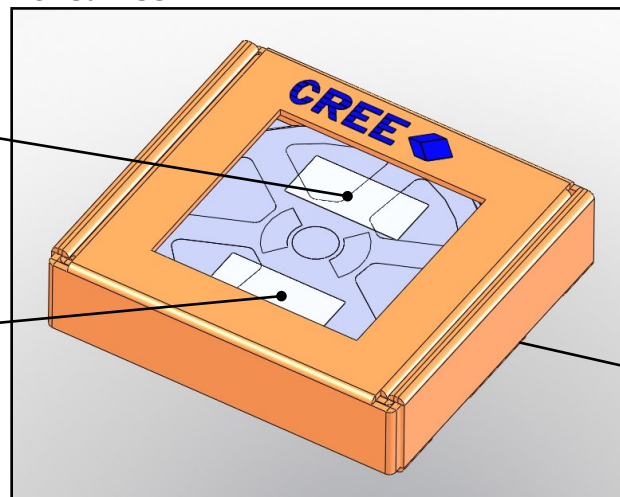

Label with Cree Order Code, Quantity, Reel ID, PO #

Label with Cree Bin Code, Quantity, Reel ID

Patent Label (on bottom of box)