

## DETAILS

<b>Product Number</b>	C14606_HB-2X2-WW
<b>Family</b>	HB
<b>Type</b>	Lens array
<b>Color</b>	clear
<b>Diameter</b>	50x50 mm
<b>Height</b>	8,5 mm
<b>Style</b>	square
<b>Optic Material</b>	PMMA
<b>Holder Material</b>	
<b>Fastening</b>	pin, screw
<b>Status</b>	production ready
<b>ROHS Compliant</b>	Yes
<b>Date Updated</b>	21/04/2016



## OPTICAL PROPERTIES

LED	Viewing	Light	Effi-	cd/lm	Connector
	Angle	Beam	ciency		
XM-L	66 deg	Very Wide	93 %	0.760	-
XP-L	66 deg	Very Wide	93 %	0.735	-
XM-L2	62 deg	Very Wide	92 %	0.803	-
XP-G3	sim: 71	Very Wide	sim: 94 %	sim: 0.760	-
XP-G2	63 deg	Very Wide	91 %	0.830	-
XP-L2	62 deg	Very Wide	93 %	0.770	-
H35C1 (LEMWA33)	63 deg	Very Wide	92 %	0.820	-
LUXEON 5050	61 deg	Very Wide	94 %	0.820	-
LUXEON MZ	sim: 66	Very Wide	sim: 94 %	sim: 0.880	-
NWSx229A	63 deg	Very Wide	85 %	0.770	-
NVSW3x9A	62 deg	Very Wide	93 %	0.830	-
Duris S8	sim: 52	Very Wide	sim: 91 %	sim: 1.100	-
Oslon Square Gen3	64 deg	Very Wide	92 %	0.820	-
Duris P9	sim: 66	Very Wide	sim: 94 %	sim: 0.920	-
Fortimo FastFlex LED board 2x8 DA G4	64 deg	Very Wide	93 %	0.790	-
LH351B	62 deg	Very Wide	86 %	0.830	-
LH351D	62 deg	Very Wide	91 %	0.780	-
LH351C	62 deg	Very Wide	93 %	0.840	-
LH508A	60 deg	Very Wide	93 %	0.820	-
Z8Y22P	59 deg	Very Wide	92 %	0.860	-
RLE G1 49x223mm 4000lm xxx EXC OTB1	deg	Very Wide	94 %	0.830	-
RLE G1 49x245mm 4000lm xxx EXC OTB1	deg	Very Wide	94 %	0.830	-
RLE G1 49x121mm 2000lm xxx EXC OTB1	deg	Very Wide	94 %	0.830	-
RLE G1 49x133mm 2000lm xxx EXC OTB1	deg	Very Wide	94 %	0.830	-

D

C

B

A

4

4

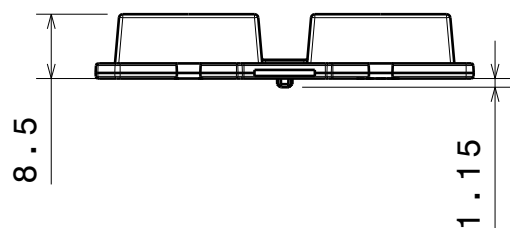

Front view

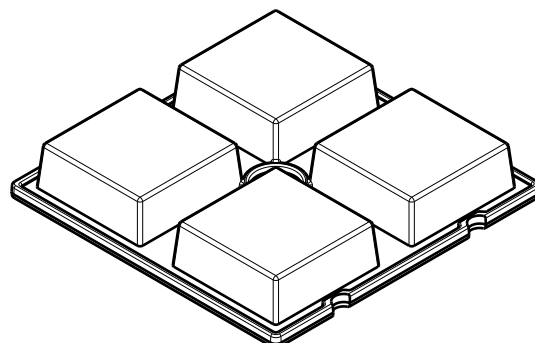

Isometric view

3

3

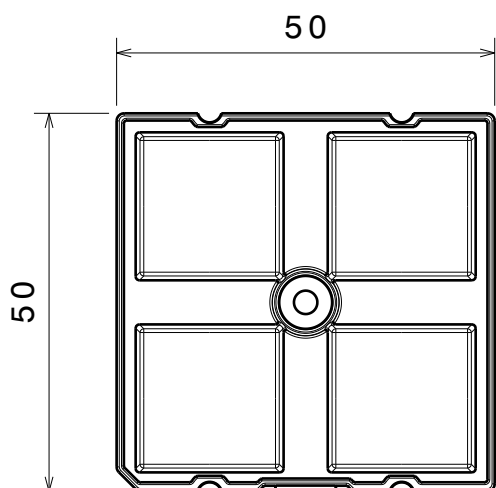

Top view

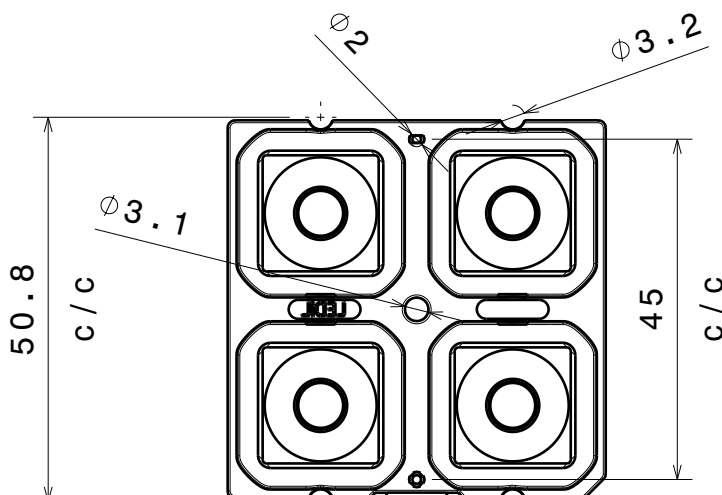

Bottom view

2

2

Tolerances if not otherwise shown  
 According to DIN ISO 2768-1  
 Linear measures:  
 up to 30mm class M, otherwise class C  
 According to DIN ISO 2768-2  
 Form and position: class L

**LEDiL**

Ledil Oy  
 Salorankatu 10  
 FIN 24240 SALO  
 Finland

THIRD ANGLE PROJECTION:

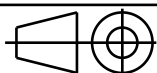

DRAWING TITLE

C14606\_HB-2X2-WW

This drawing is the property  
 of LEDiL Oy. It may not be  
 reproduced, copied or  
 communicated without a written  
 agreement with LEDiL Oy.

SIZE

PART NUMBER

A4

C14606

SCALE

1:1

WEIGHT

10,53 g

SHEET

1/1

1

1

D

A

Luminaire: LEDiL Oy C14606\_HB-2X2-WW\_(XM-L)

Lamps: 1 x Cree\_XM-L\_2x2\_(XMLAWT-00-0000-000LT20E7)\_338.257lm@250mA\_P=2.75205W\_η=0.2498A

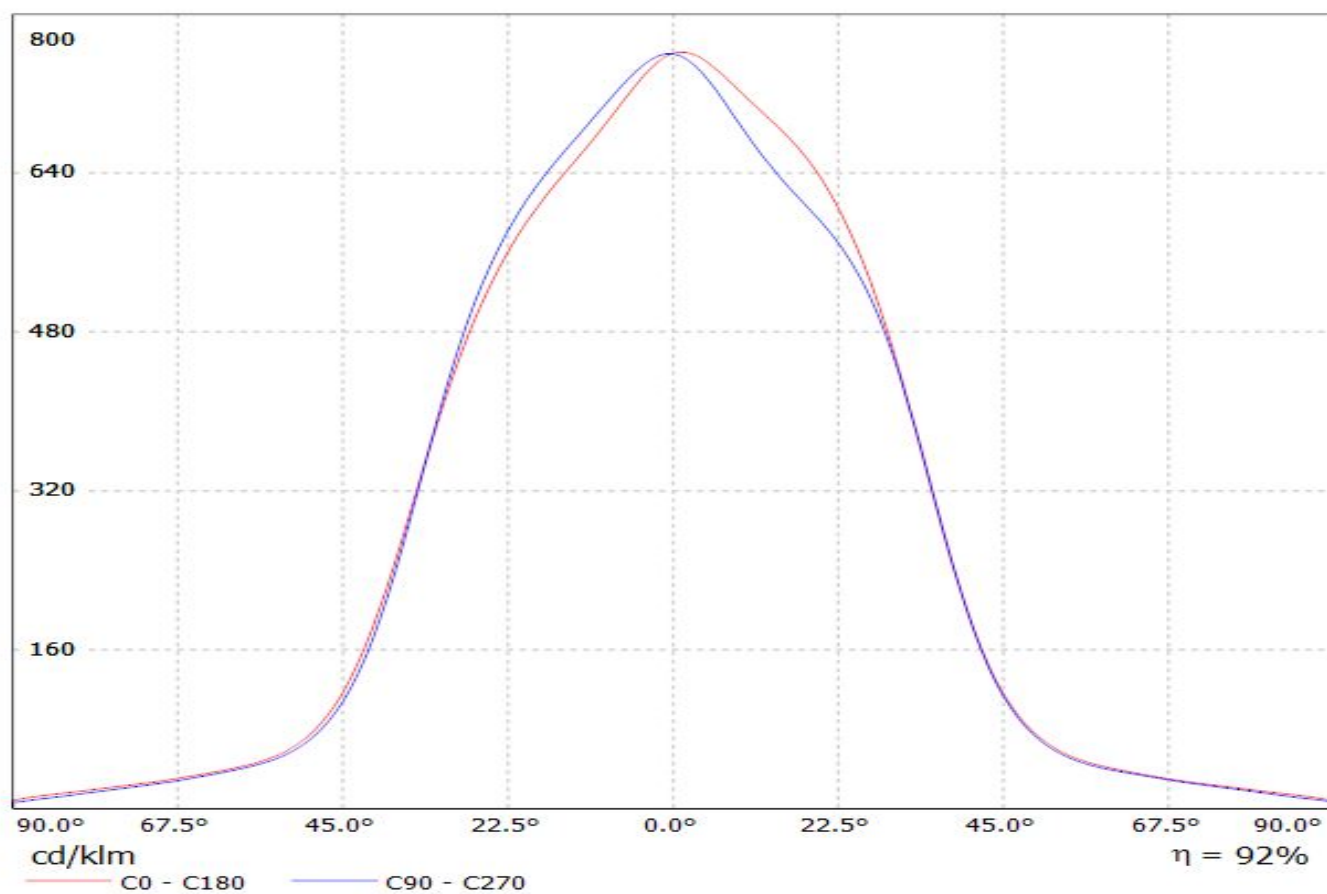

Luminaire: LEDiL Oy C14606\_HB-2X2-WW\_(XP-L)

Lamps: 1 x Cree\_XP-L\_(XPLAWT-1B0-V40-00-0001)\_496.74lm@250mA\_P=2.80138W\_I=0.2499A

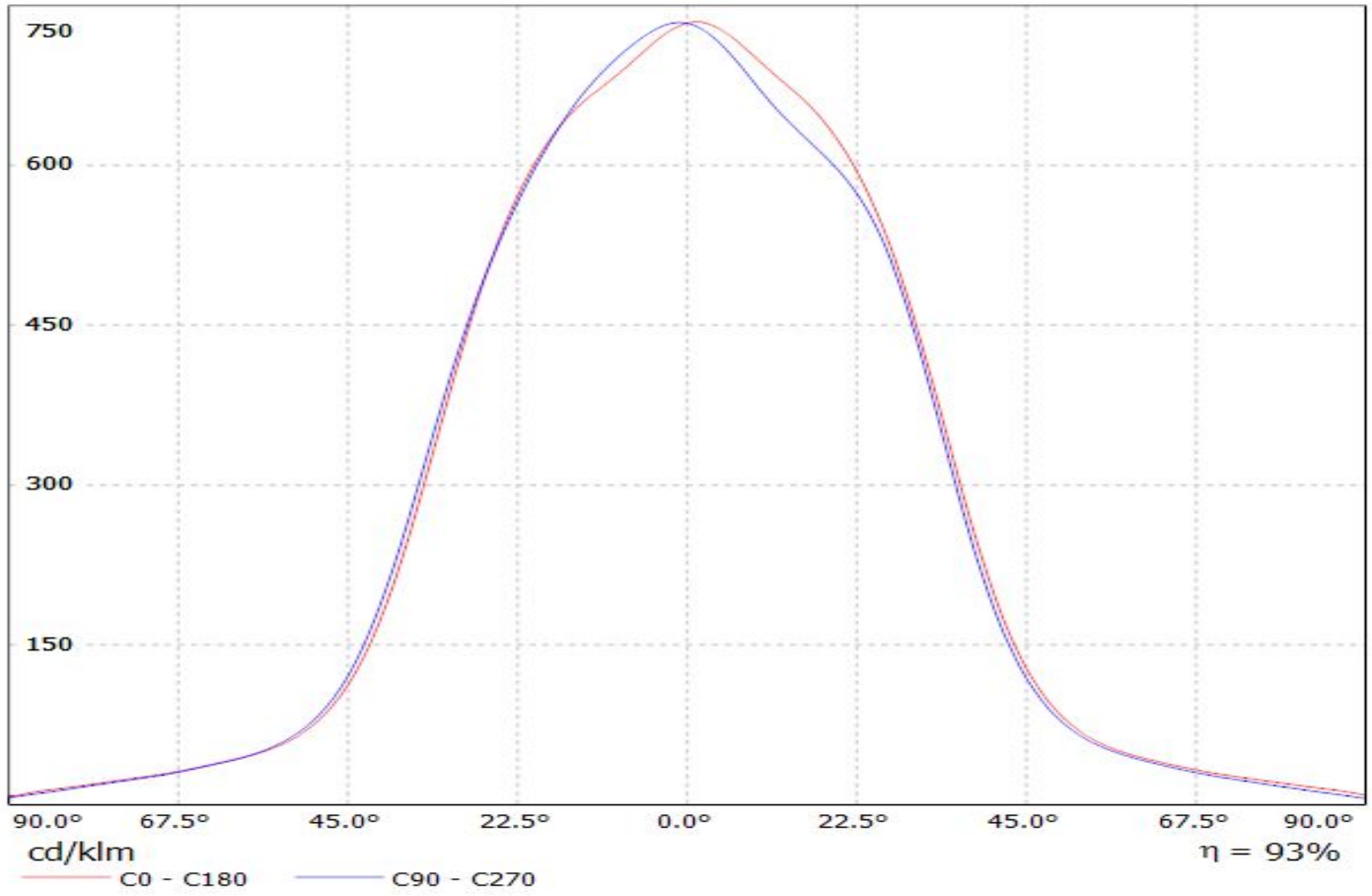

Luminaire: LEDiL Oy C14606\_HB-2X2-WW\_(XM-L2)

Lamps: 1 x Cree\_XM-L2\_2X2\_(XMLBWT-0-7B4-0L-0001)\_354.093lm@250mA\_P=2.81687W\_η=0.2499A

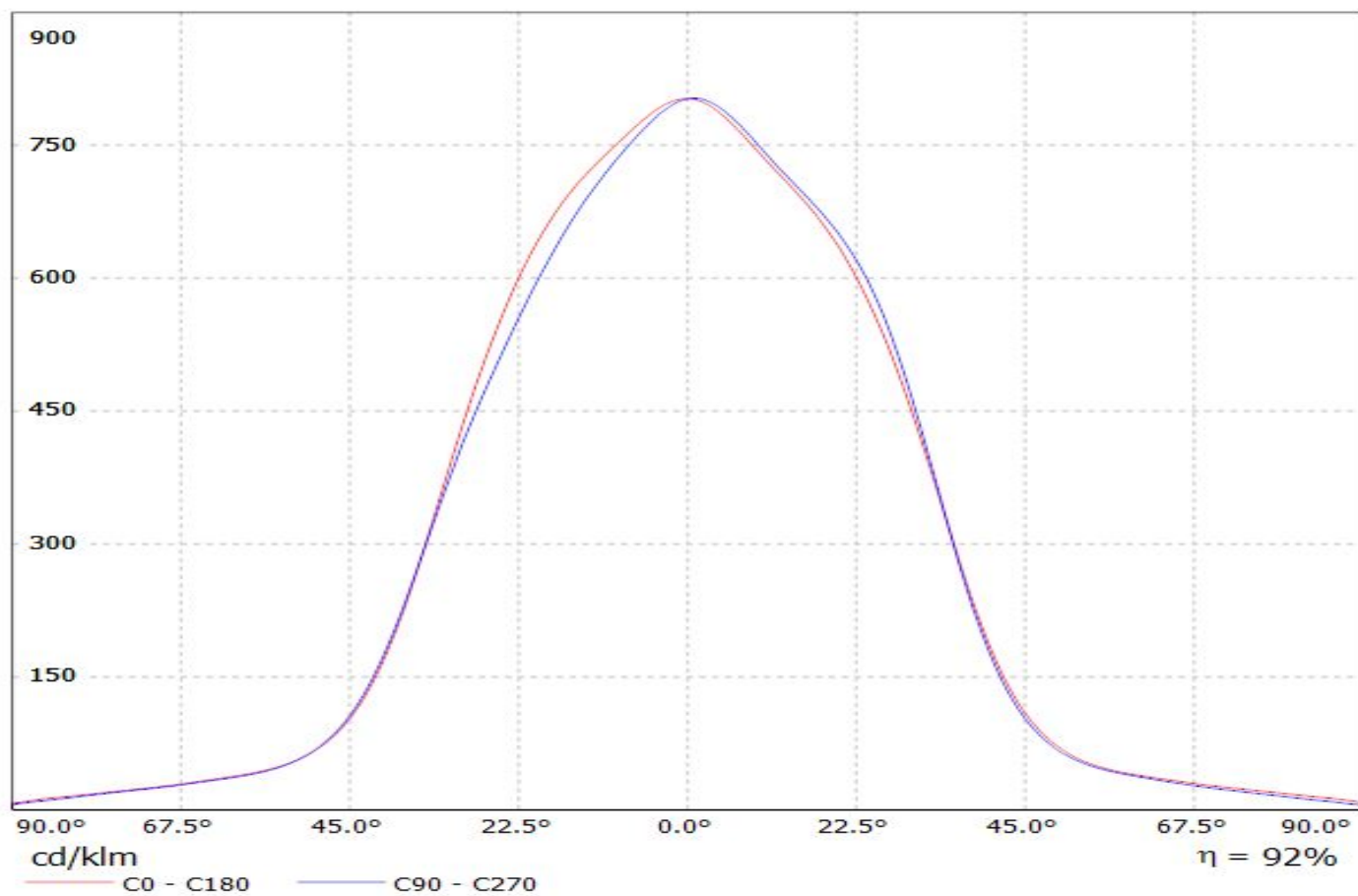

Luminaire: Ledil Oy C14606\_HB-2X2-WW\_(XP-G3)\_SIMULATED  
Lamps: 1 x Cree XP-G3

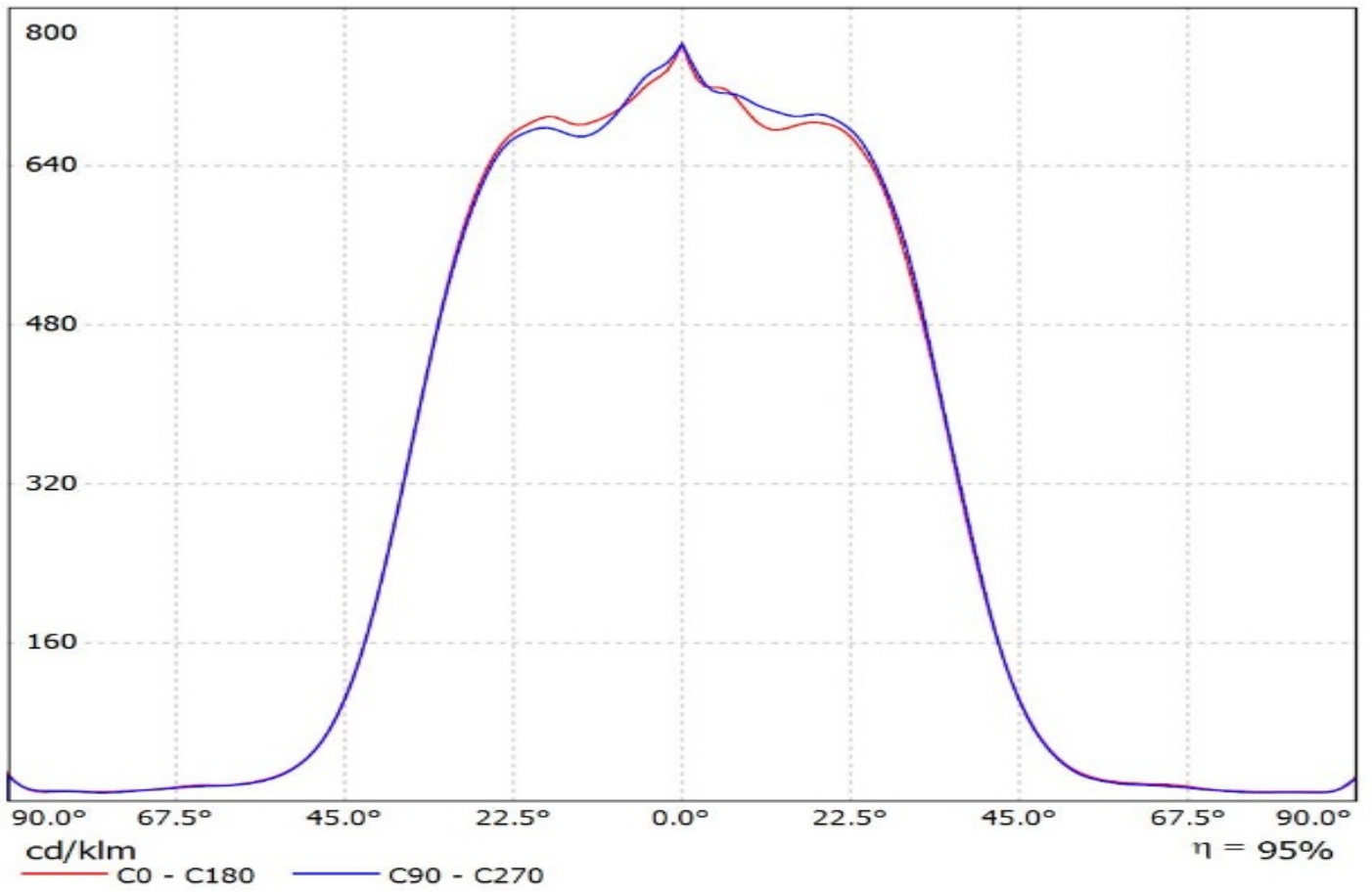

Luminaire: Ledil C14606\_HB-2X2-WW\_(XP-G2)

Lamps: 2 x Cree\_XP-G2\_2x2\_(XPGBWT-L1-000-00-G51)\_421.786lm@250mA\_P=2.9665W\_I=0.250A - 3.00 W

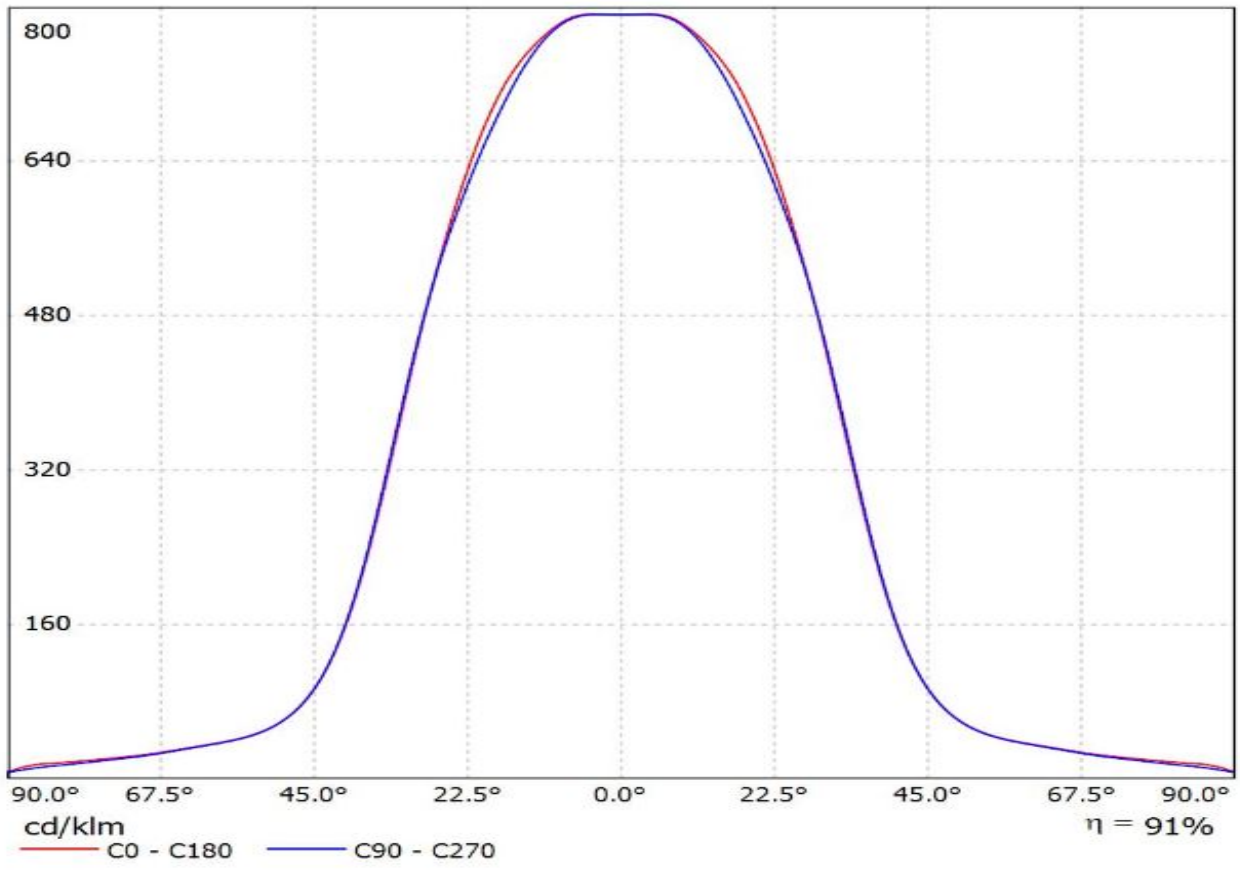

Luminaire: Ledil C14606\_HB-2X2-WW\_(XP-L2)

Lamps: 1 x Cree\_XP-L2\_2x2\_(XPLBWT-00-0000-000BV50E3)550.93lm@250mA\_P=2.7815W\_I=0.25A

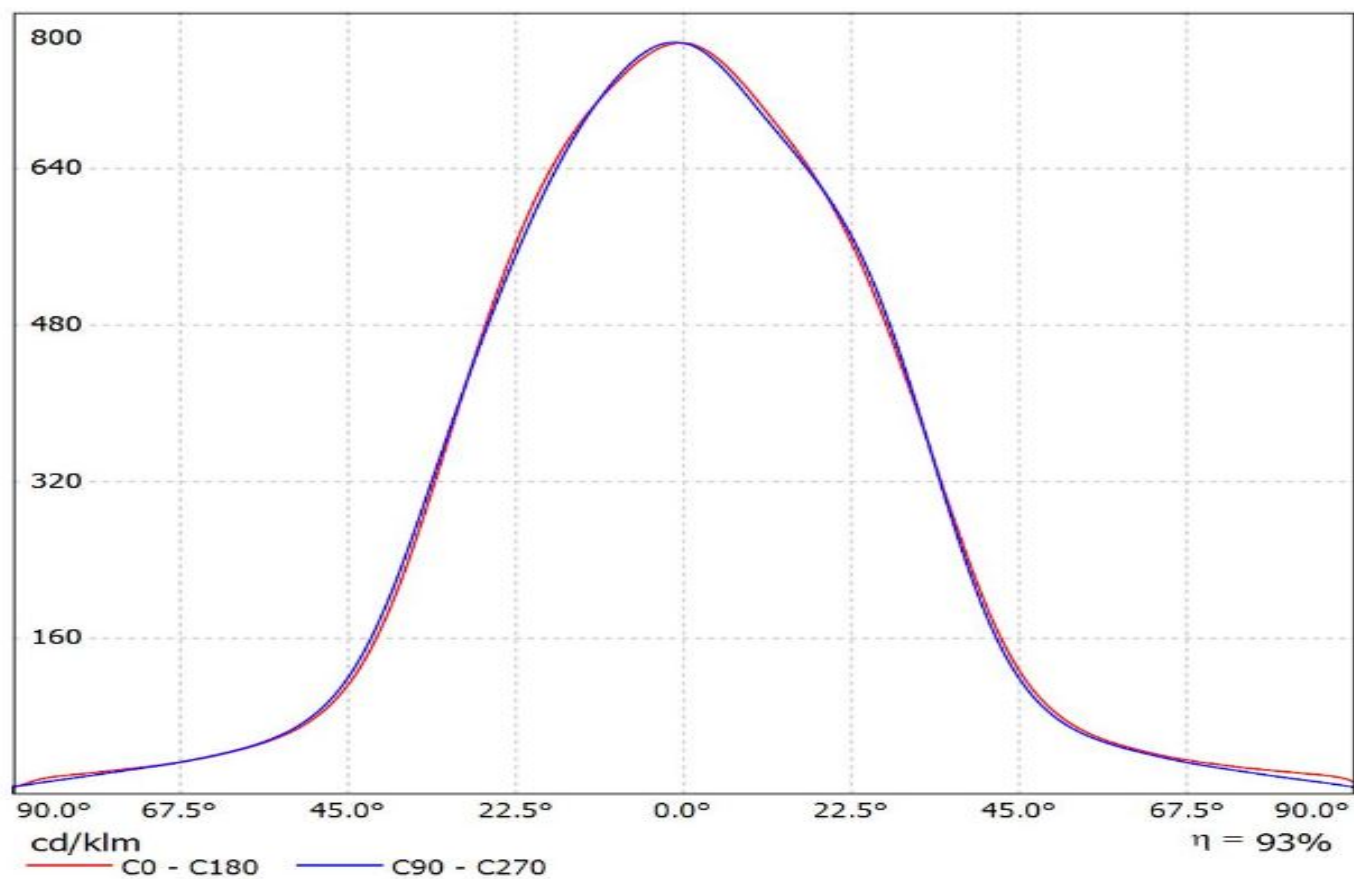



Luminaire: Ledil C14606\_HB-2X2-WW\_(H35C1)  
Lamps: 2 x LG\_H35C1\_2x2\_477.216lm@250mA\_P=2.87475W\_I=0.250A

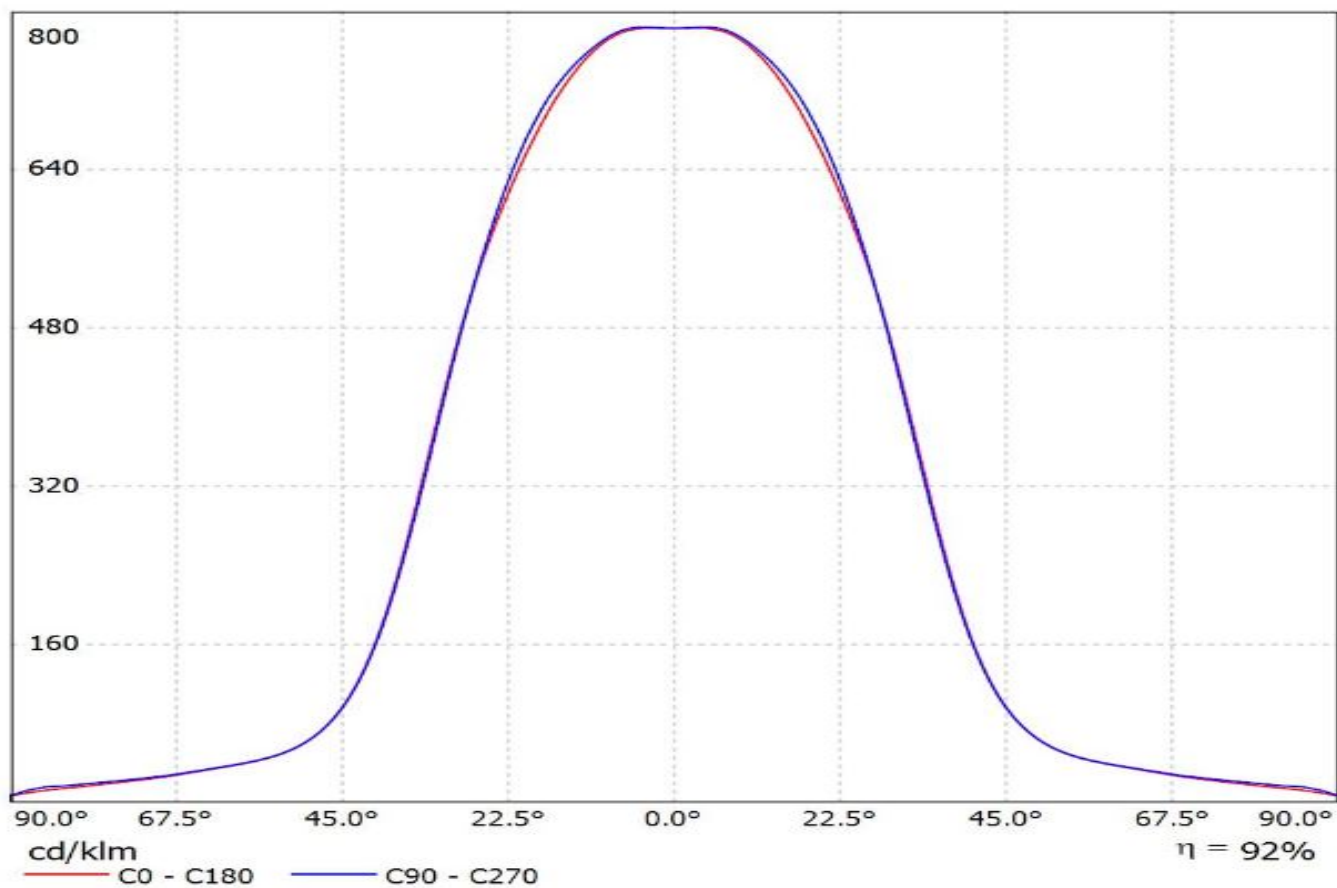

Luminaire: LEDiL Oy C14606\_HB-2X2-WW\_(Luxeon\_5050)

Lamps: 1 x Luxeon\_5050\_2x2\_1270.76lm@80mA\_CCT=5700K\_P=7.35815W\_I=0.080A\_70CRI

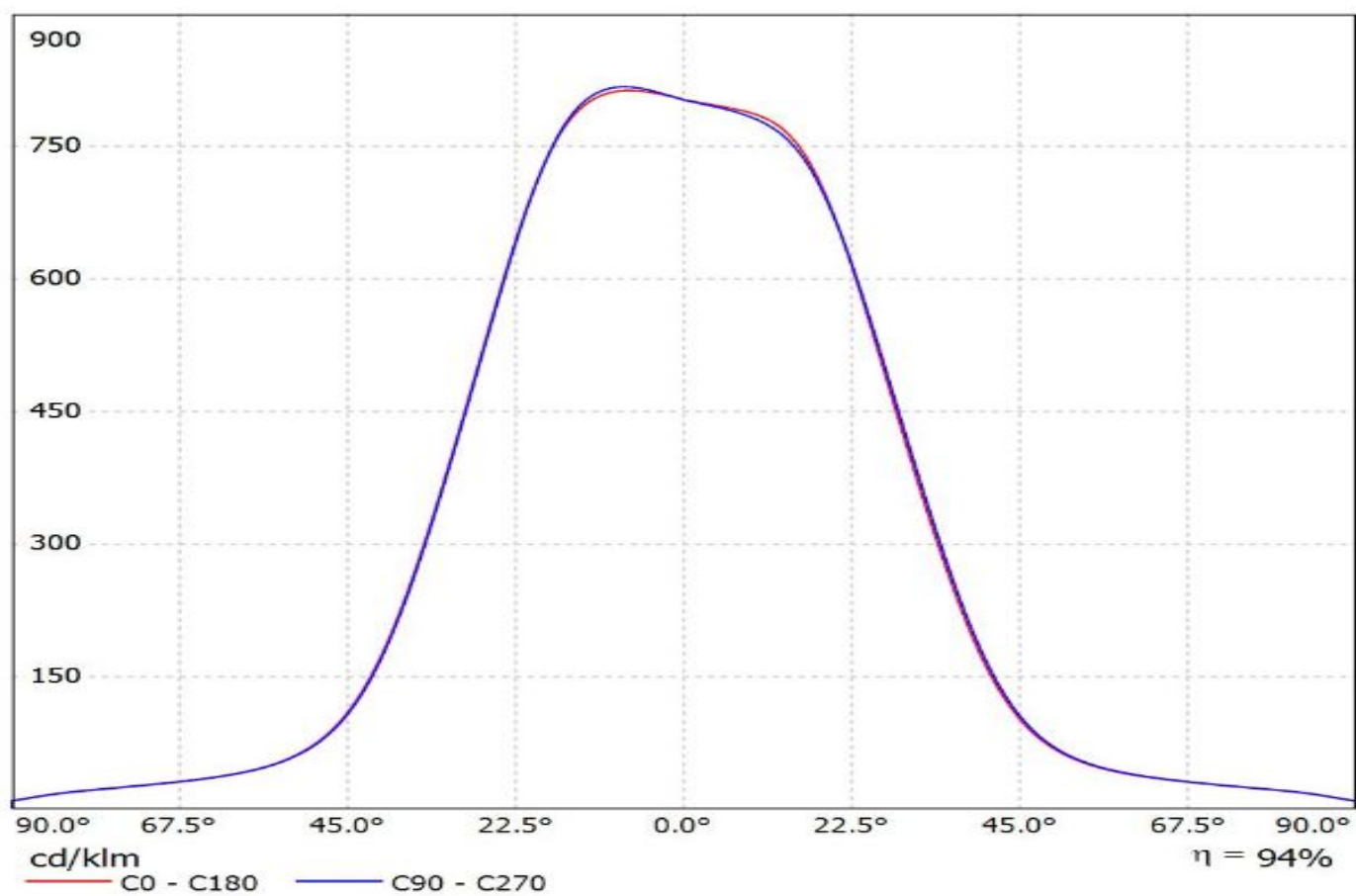

Luminaire: Ledil Oy C14606\_HB-2X2-WW\_(Luxeon\_MZ)\_SIMULATED  
Lamps: 1 x Lumileds Luxeon MZ

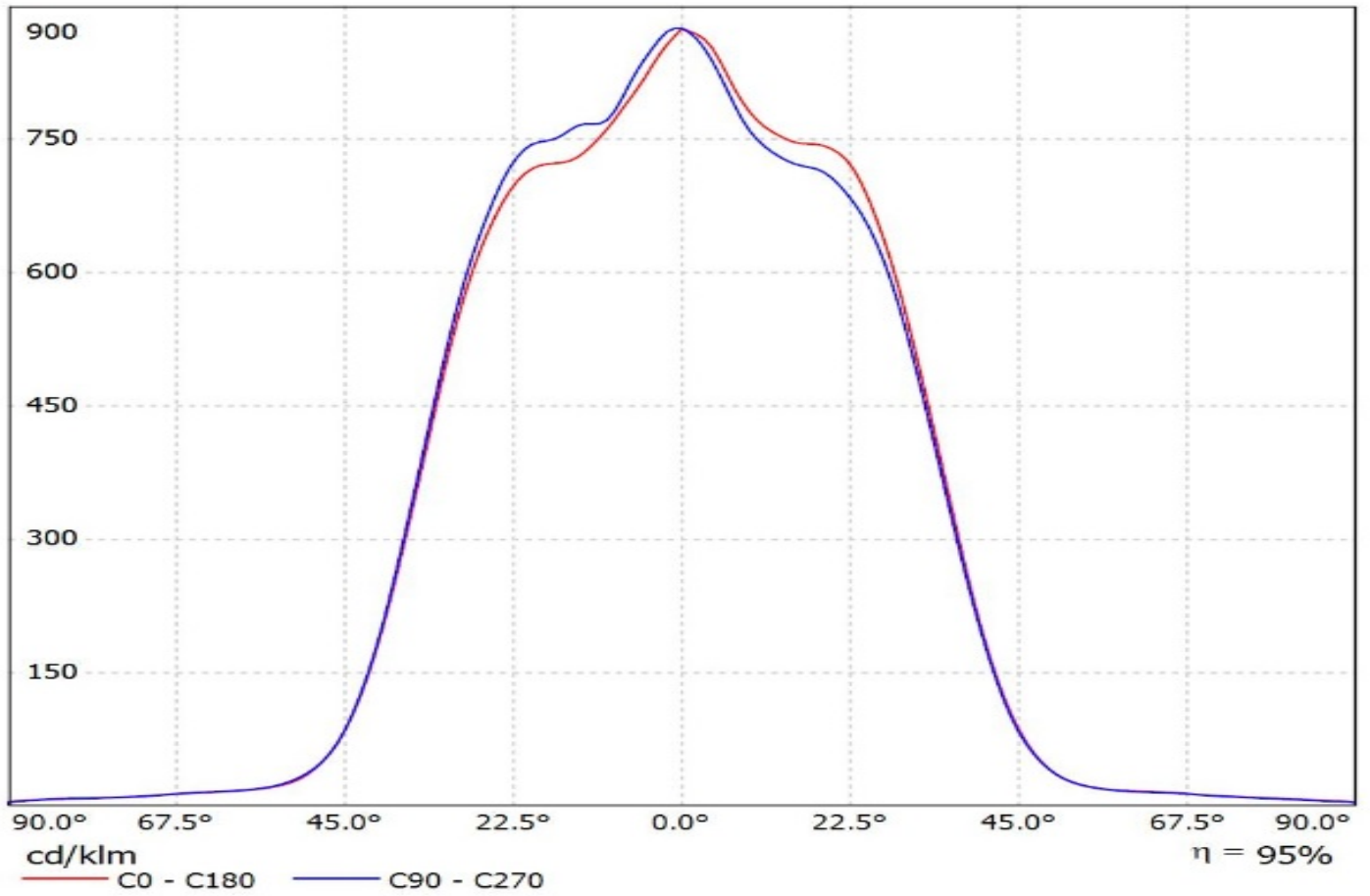

Luminaire: LEDiL Oy C14606\_HB-2X2-WW (NWSL229AE)  
Lamps: 1 x Nichia\_2X2\_NWSL229AE\_476.548lm@250mA\_P=2.7515W\_I=0.250A

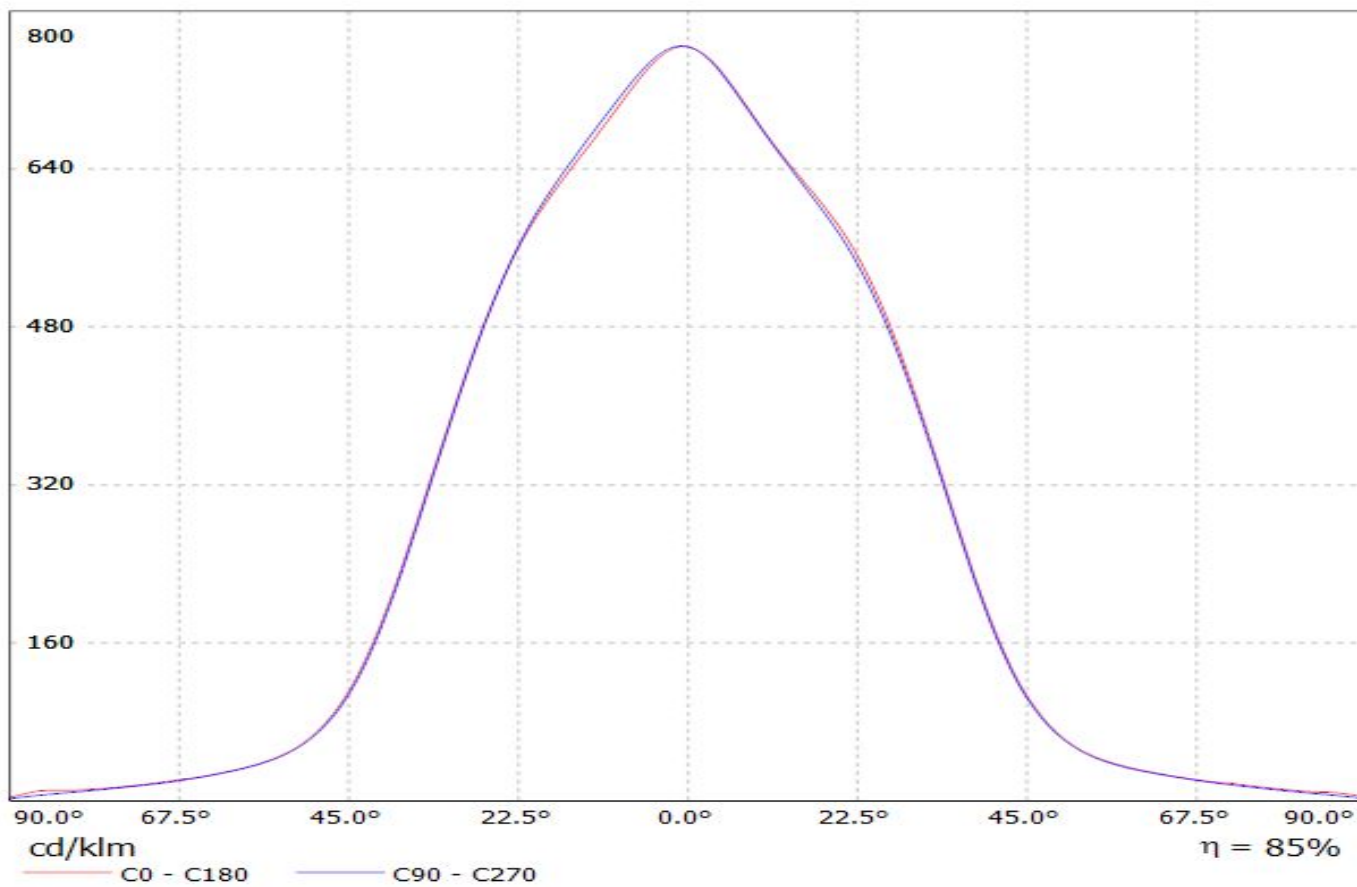

Luminaire: LEDiL Oy C14606\_HB-2X2-WW\_(NVSW319AE)

Lamps: 1 x Nichia\_NVSW319AE\_(sm405D440f2L2R70)\_500.359lm@250mA\_P=2.79351W\_I=0.25A

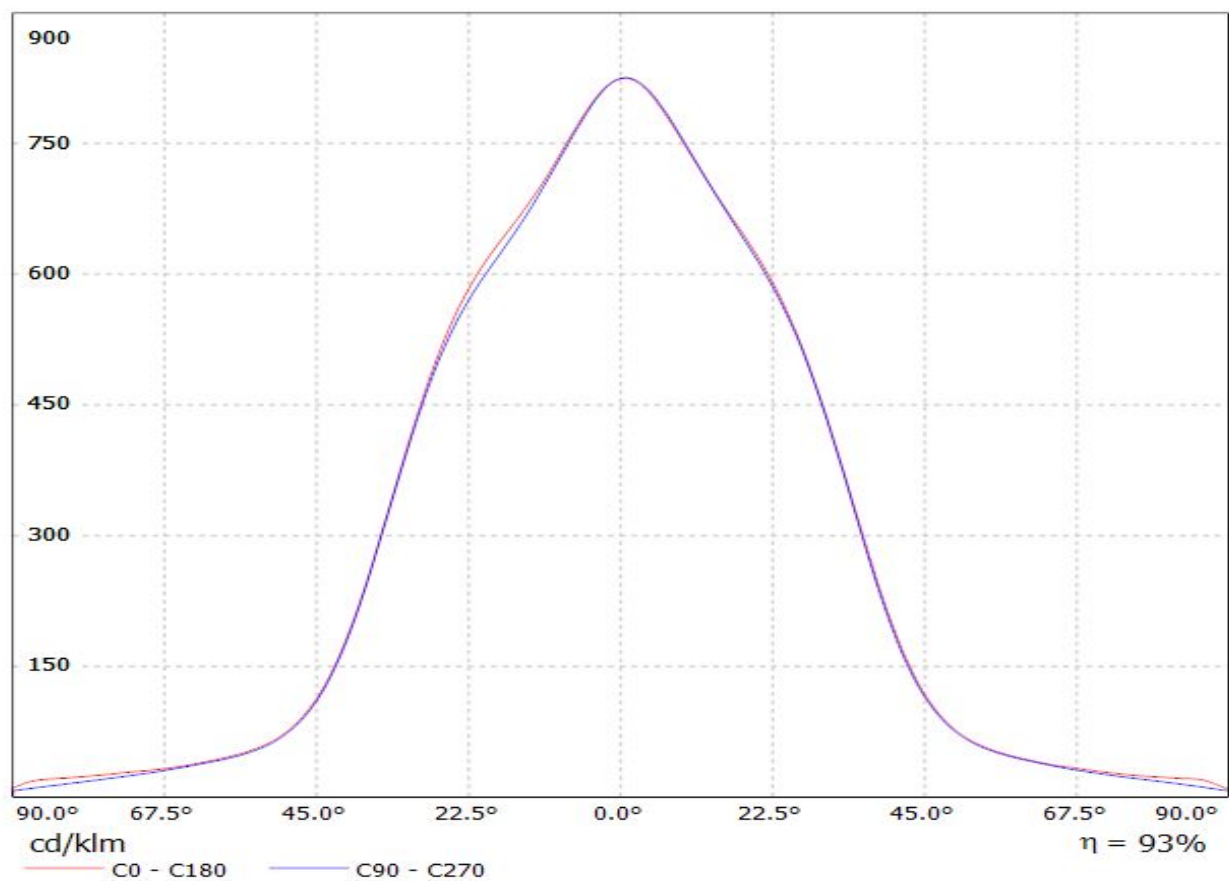

Luminaire: Ledil C14606\_HB-2X2-WW\_(Square\_Gen3)

Lamps: 1 x Osram\_Square\_Gen3\_(GW\_CSSRM2.PM)\_461.082lm@250mA\_P=2.79075W\_I=0.250A

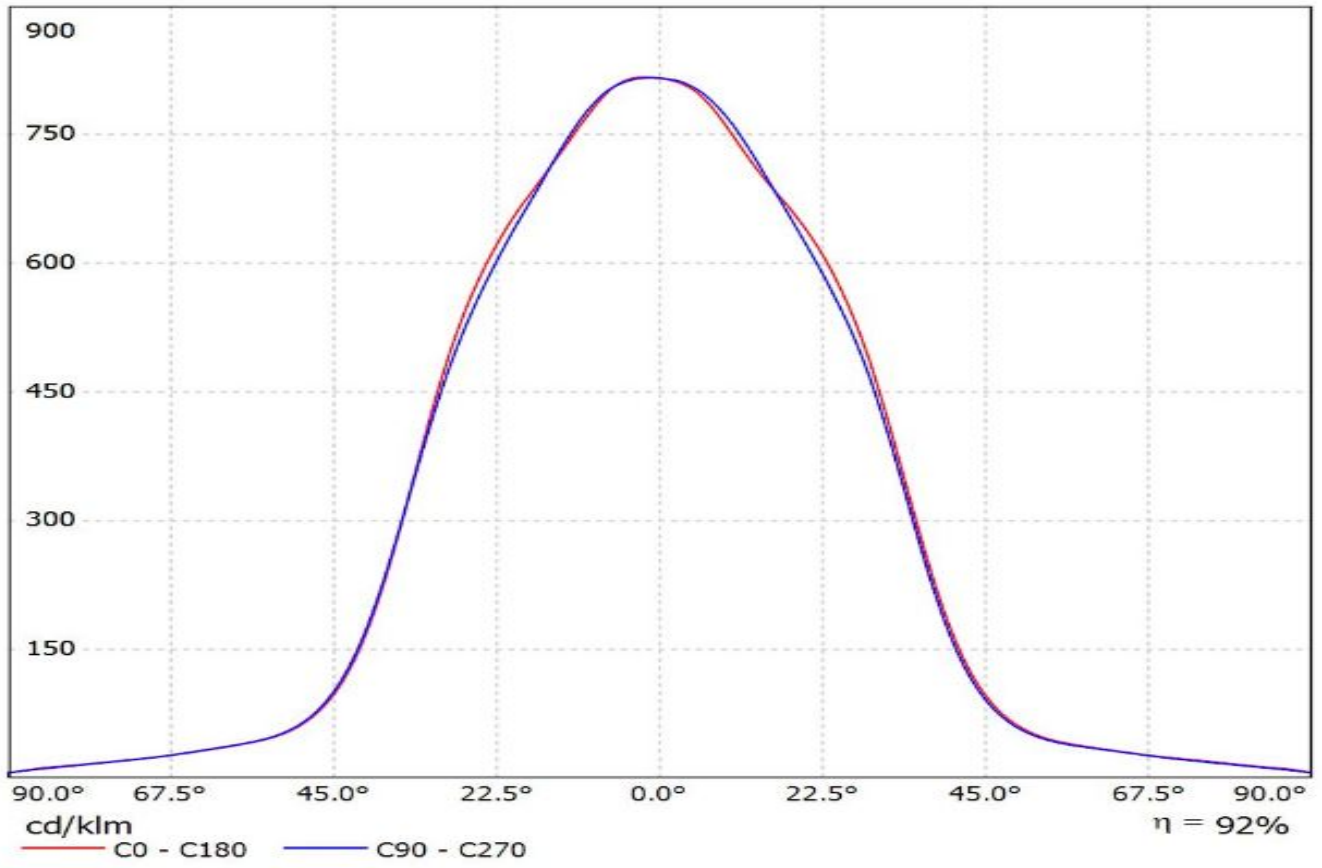

Luminaire: Ledil Oy C14606\_HB-2X2-WW\_OSRAM\_DURIS\_P9\_SIMULATED  
Lamps: 1 x OSRAM DURIS P9

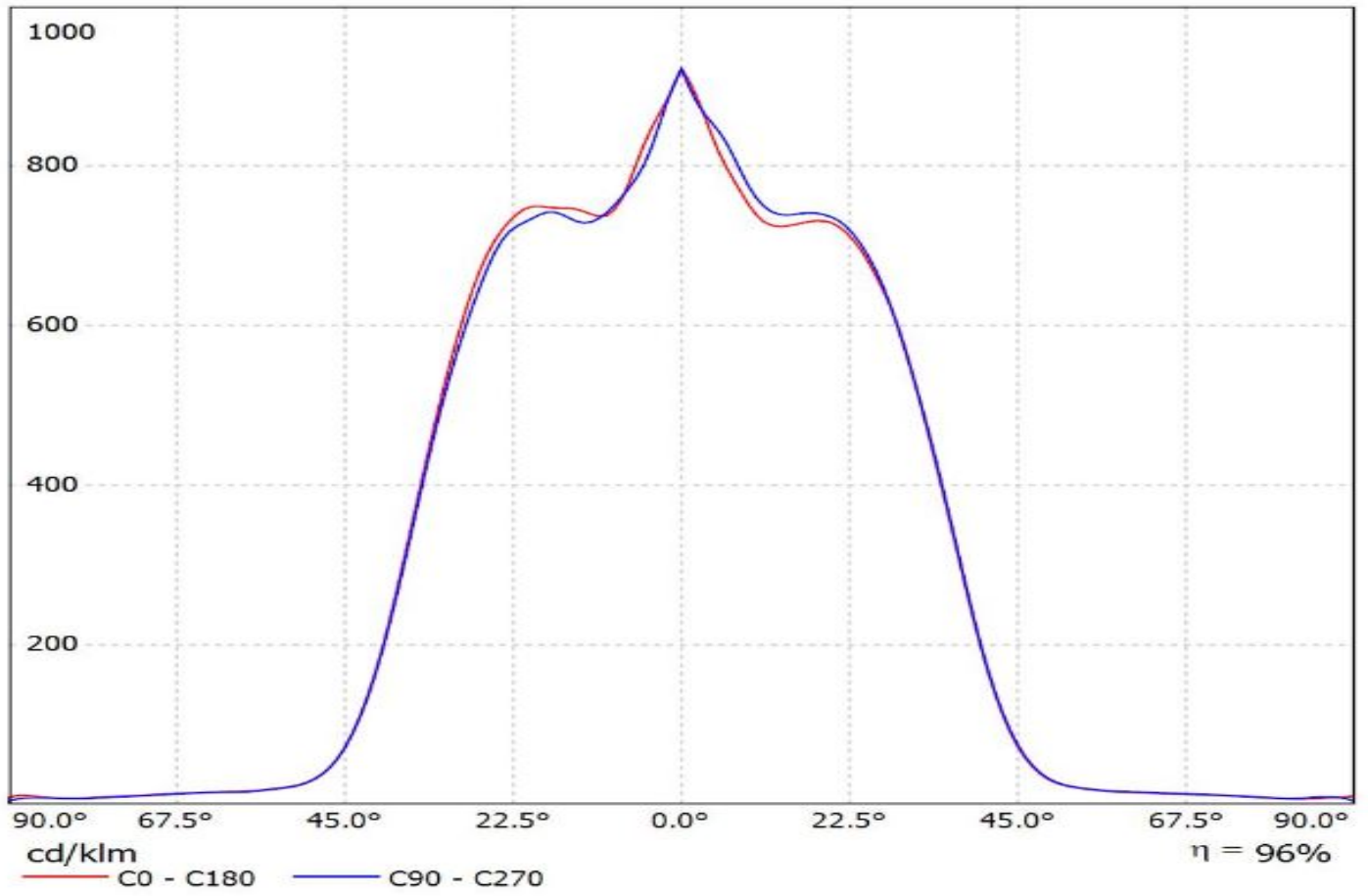

Luminaire: Ledil C14606\_HB-2X2-WW\_(Fortimo\_FastFlex\_LED\_board\_2x8/740\_DA\_G3)  
Lamps: 1 x Fortimo\_FastFlex\_LED\_board\_2x8/740\_DA\_G3\_1823.98lm@250mA\_P=11.65W\_η=0.25A

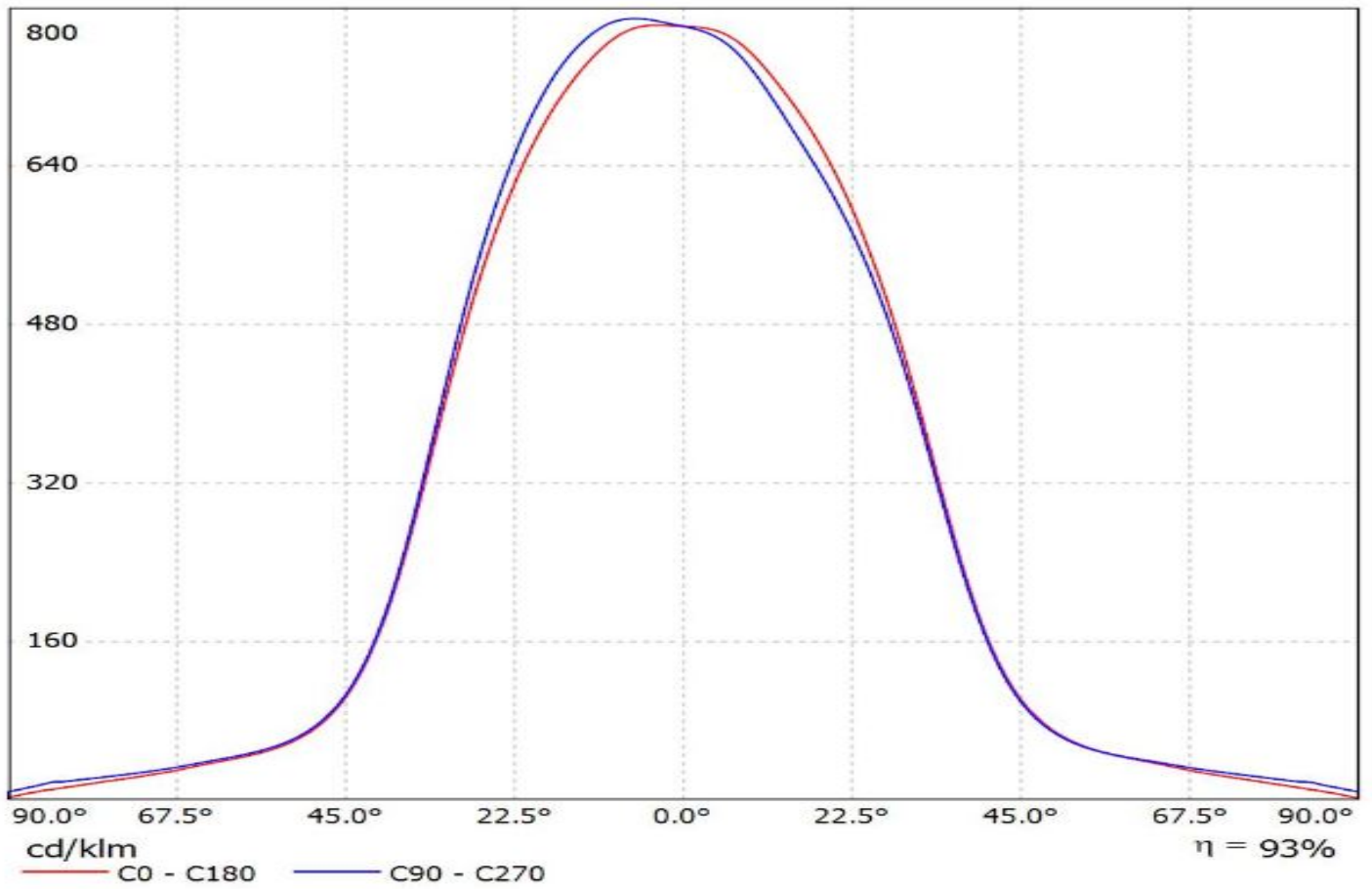



Luminaire: Ledil C14606\_HB-2X2-WW\_(LH351B)

Lamps: 1 x Samsung\_LH351B\_2x2\_444.178lm@250mA\_P=2.8535W\_I=0.25A

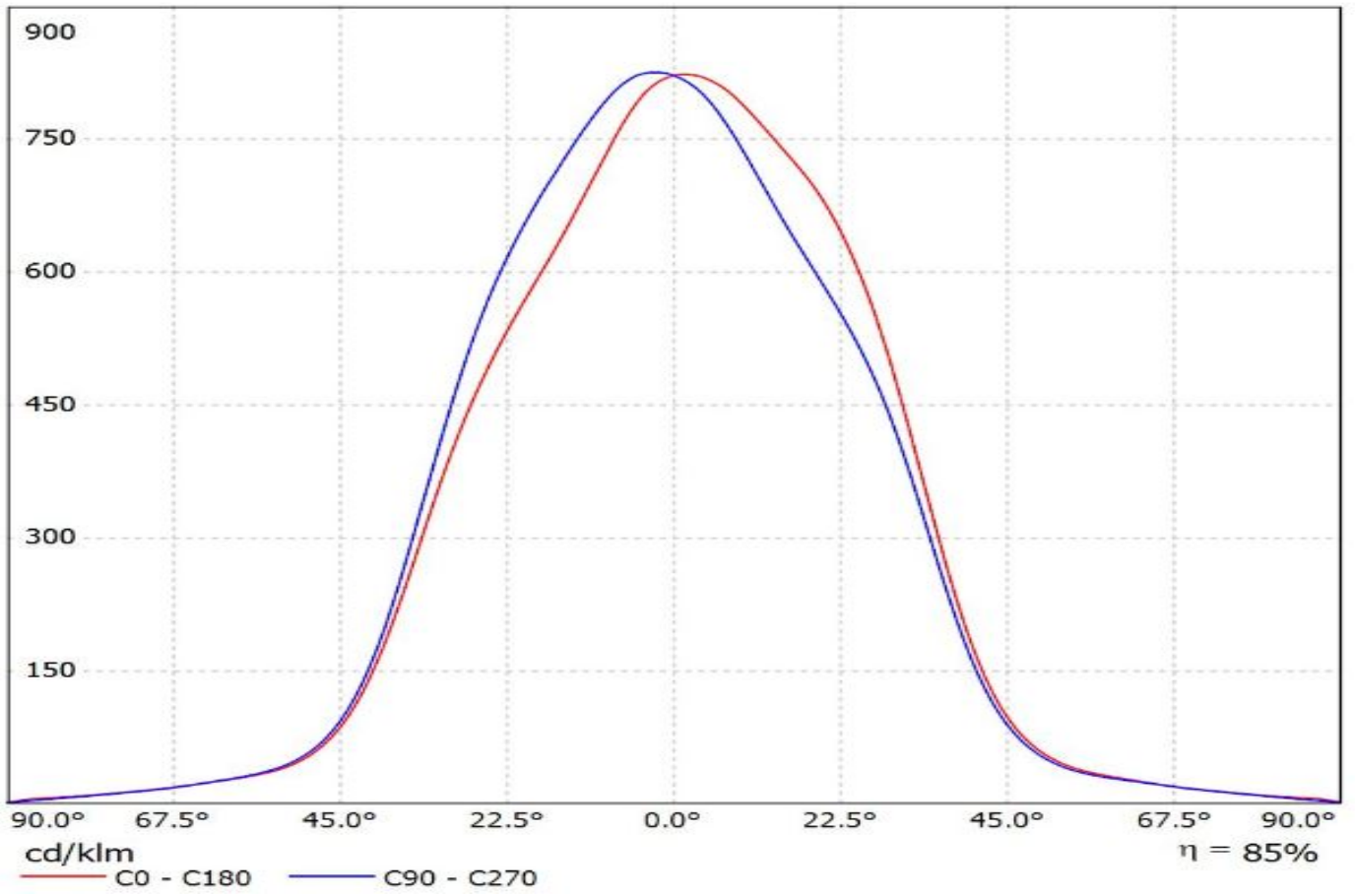

Luminaire: Ledil C14606\_HB-2X2-WW\_(LH351D)

Lamps: 2 x Samsung\_LH351D\_536.957lm@250mA\_P=2.7695W\_I=0.250A

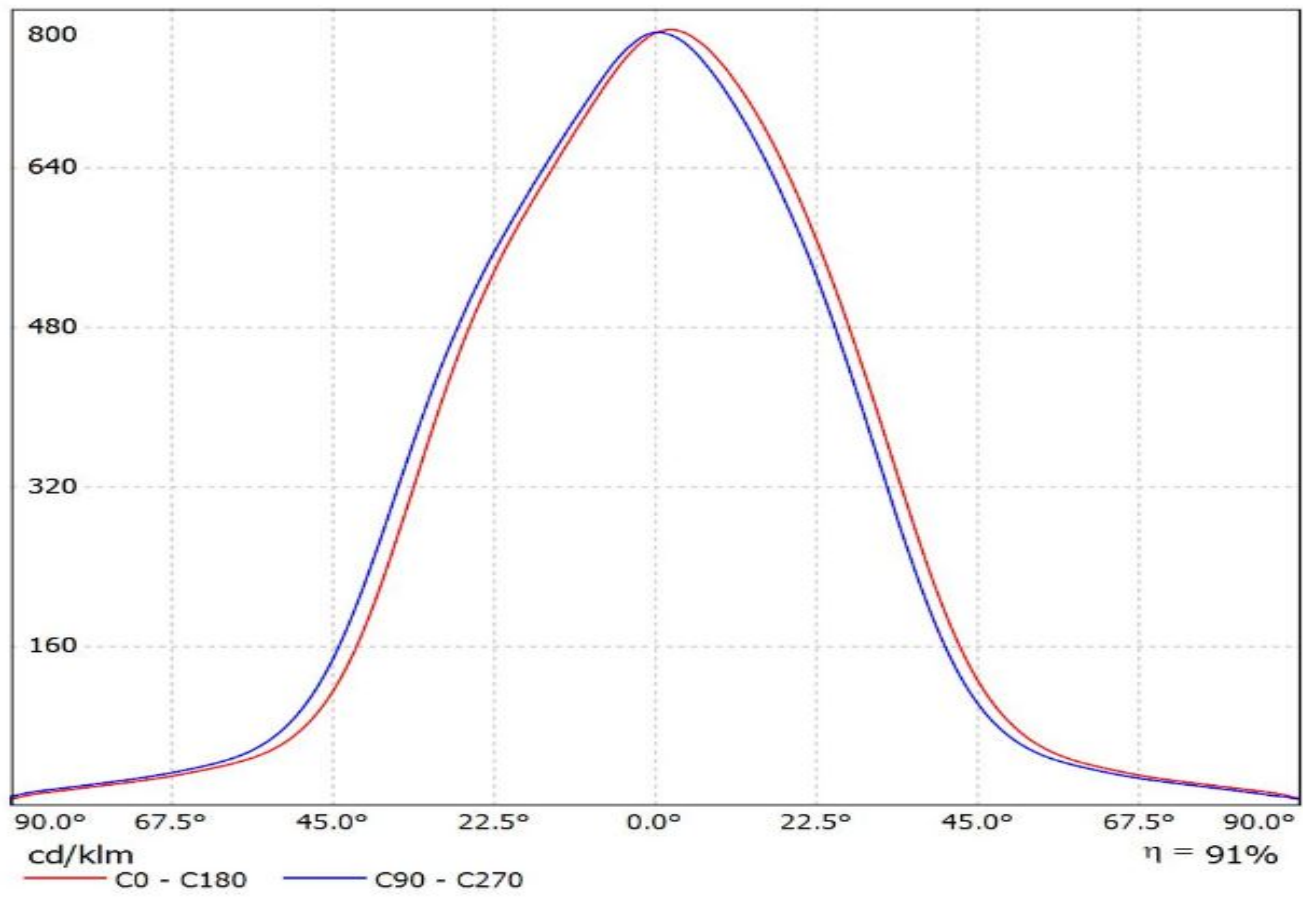

Luminaire: Ledil C14606\_HB-2X2-WW\_(LH351C)  
Lamps: 1 x Samsung\_LH351C\_518.223lm@250mA\_P=2.85225W\_I=0.25A

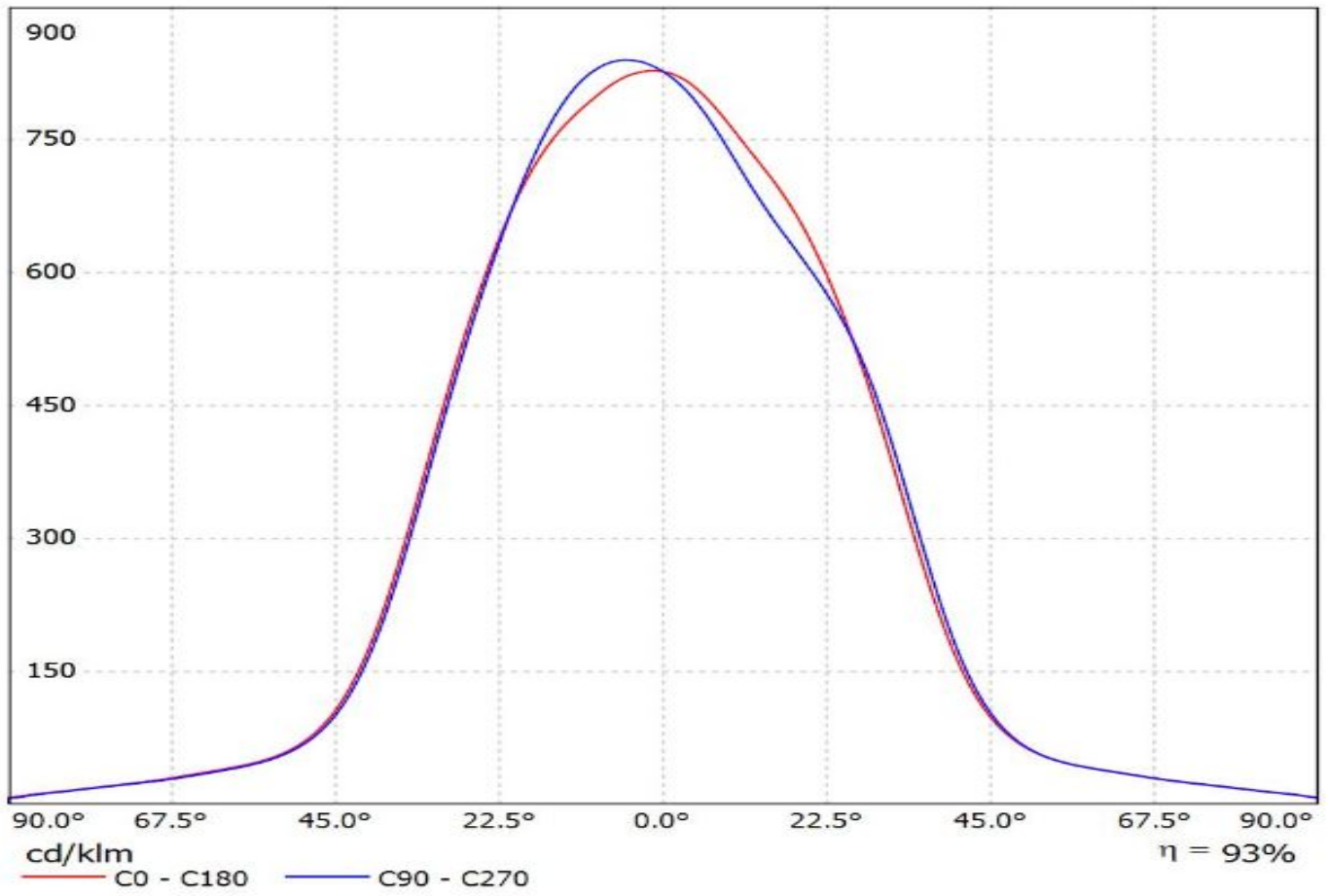

Luminaire: Ledil C14606\_HB-2X2-WW\_(LH508A)

Lamps: 1 x Samsung\_LH508A\_2x2\_2060.04lm@160mA\_CCT=5000K\_CRI=80\_P=15.5405W\_I=0.16A

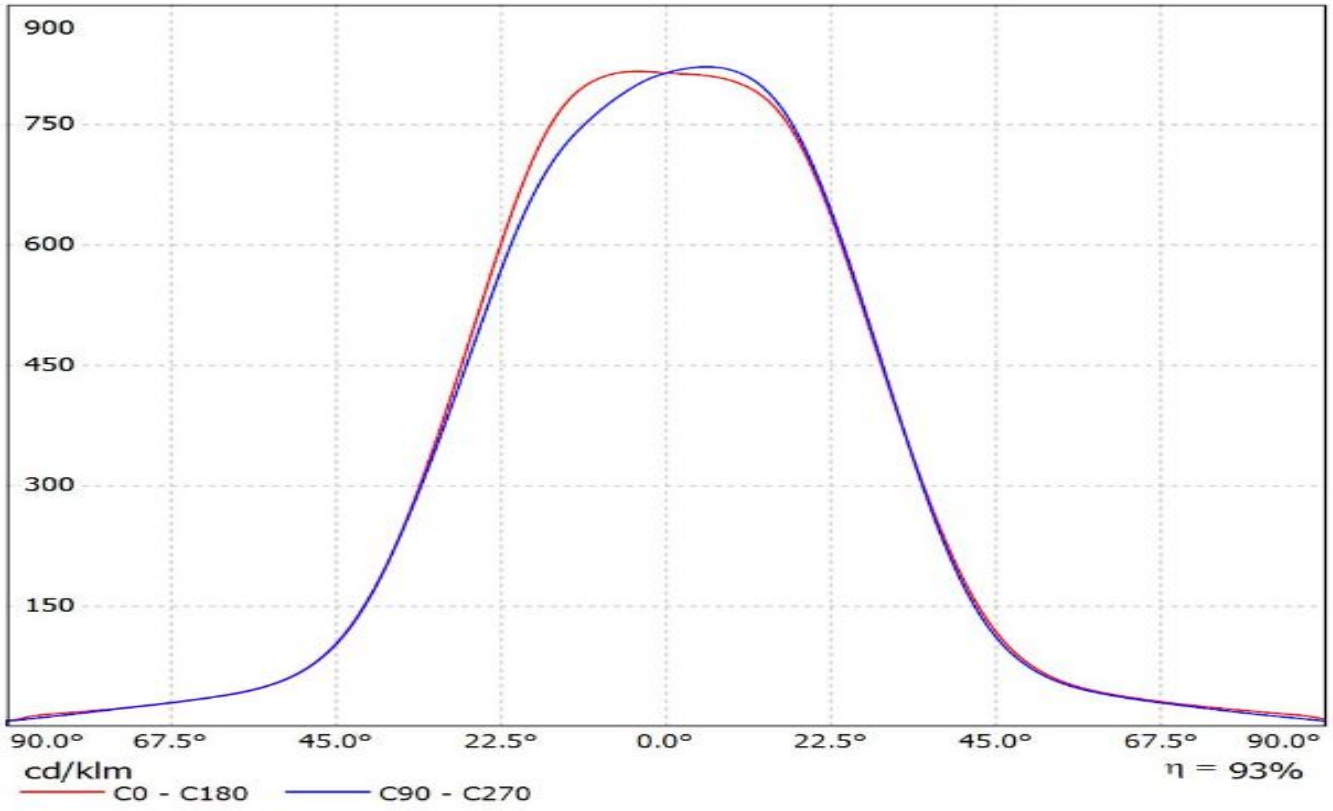

Luminaire: Ledil C14606\_HB-2X2-WW\_(Z8Y22plus)

Lamps: 1 x Seoul\_Z8Y22plus\_(W6E2G)\_513.996lm@250mA\_P=2.754W\_I=0.250A

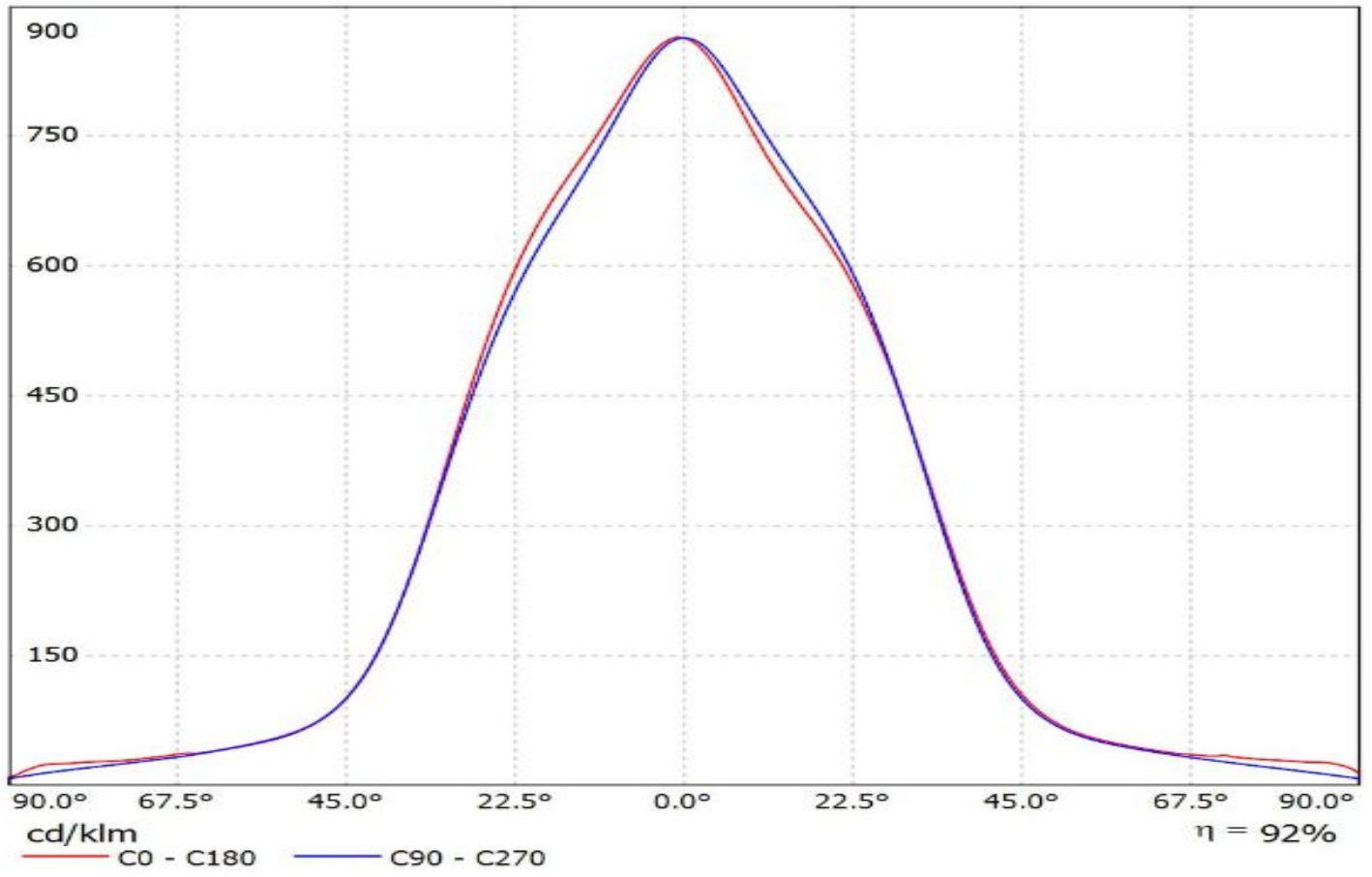

Luminaire: LEDiL Oy C14606\_HB-2X2-WW\_(Tridonic\_Module\_RLE\_G1)  
Lamps: 1 x Tridonic\_Module\_RLE\_G1\_4594.42lm@700mA\_P=32.1515W\_I=0.700A

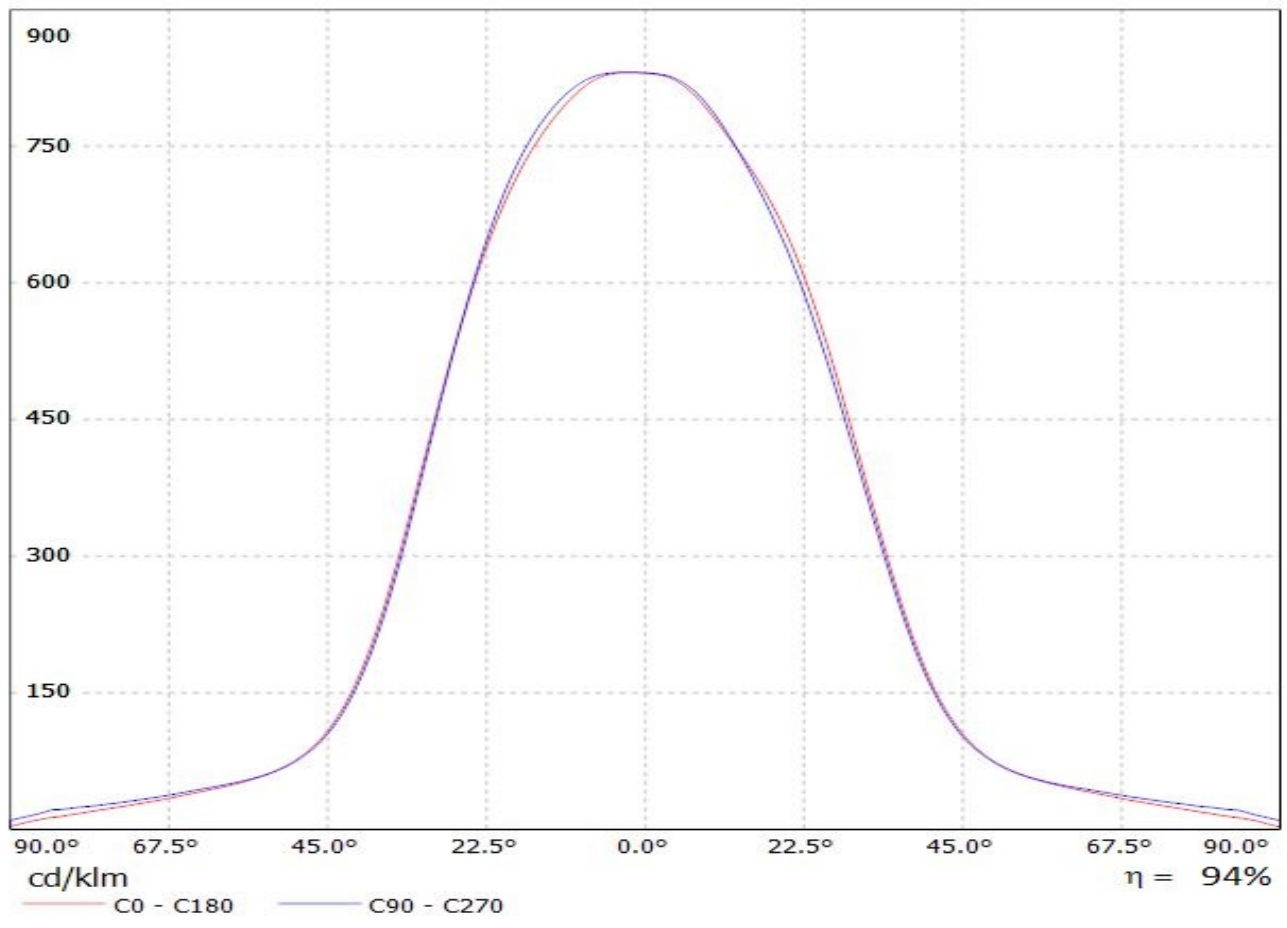

Luminaire: LEDiL Oy C14606\_HB-2X2-WW\_(Tridonic\_Module\_RLE\_G1)  
Lamps: 1 x Tridonic\_Module\_RLE\_G1\_4594.42lm@700mA\_P=32.1515W\_I=0.700A

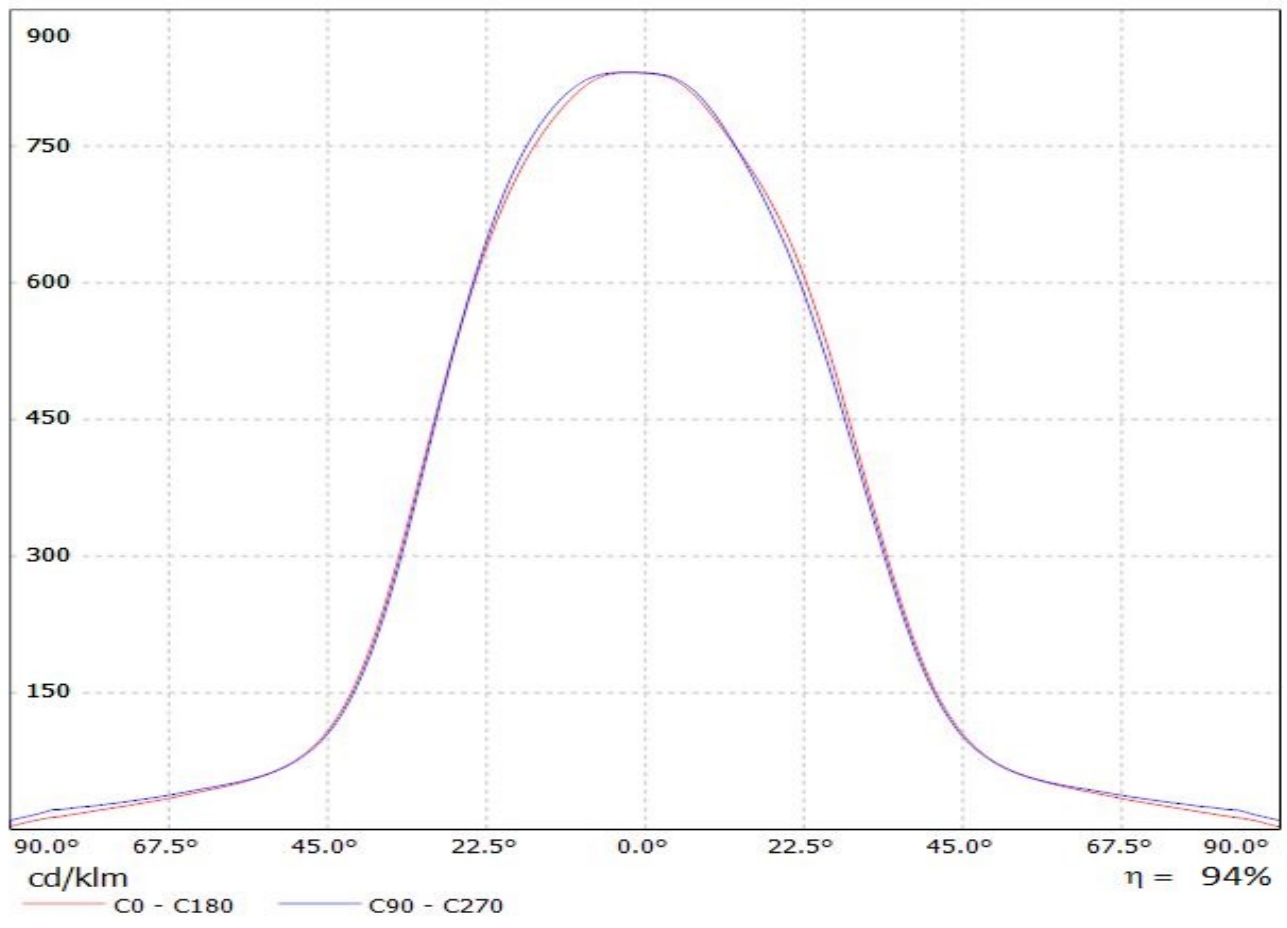

Luminaire: LEDiL Oy C14606\_HB-2X2-WW\_(Tridonic\_Module\_RLE\_G1)  
Lamps: 1 x Tridonic\_Module\_RLE\_G1\_2288lm@700mA\_P=16W\_I=0.700A

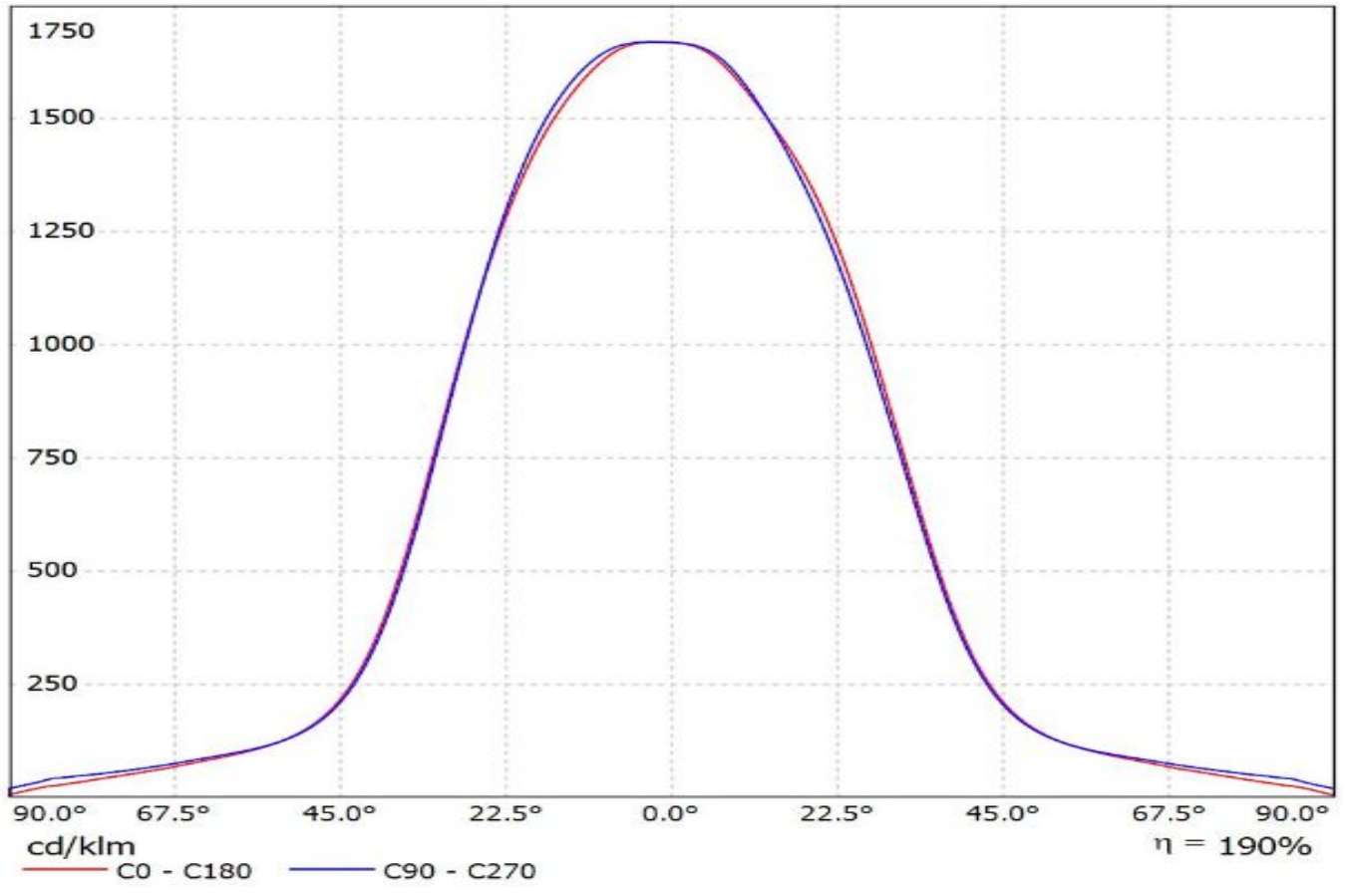



Luminaire: LEDiL Oy C14606\_HB-2X2-WW\_(Tridonic\_Module\_RLE\_G1)  
Lamps: 1 x Tridonic\_Module\_RLE\_G1\_2288lm@700mA\_P=16W\_I=0.700A

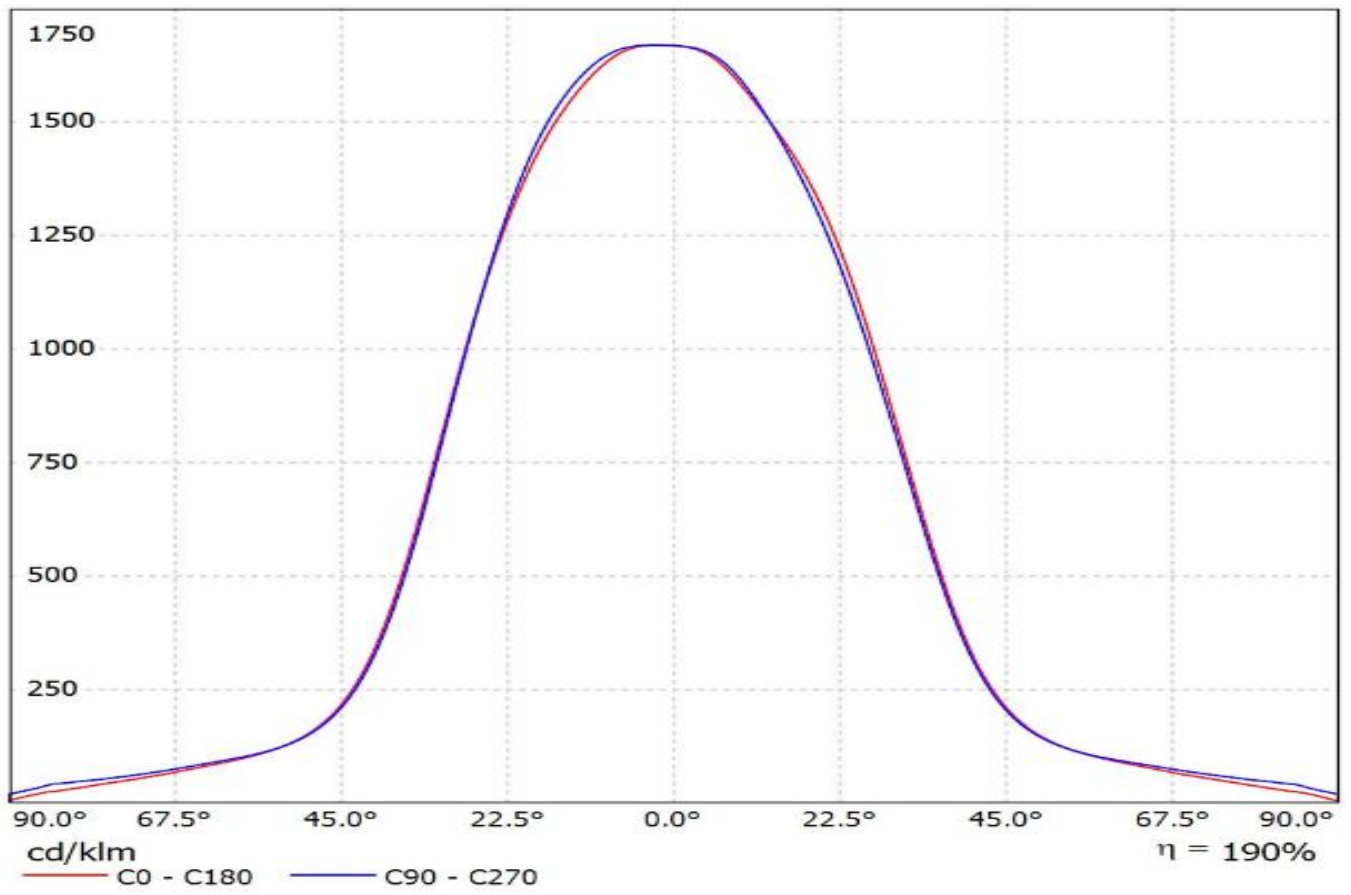

Luminaire: LEDiL Oy C14606\_HB-2X2-WW\_(XM-L)

Lamps: 1 x Cree\_XM-L\_2x2\_(XMLAWT-00-0000-000LT20E7)\_338.257lm@250mA\_P=2.75205W\_I=0.2498A

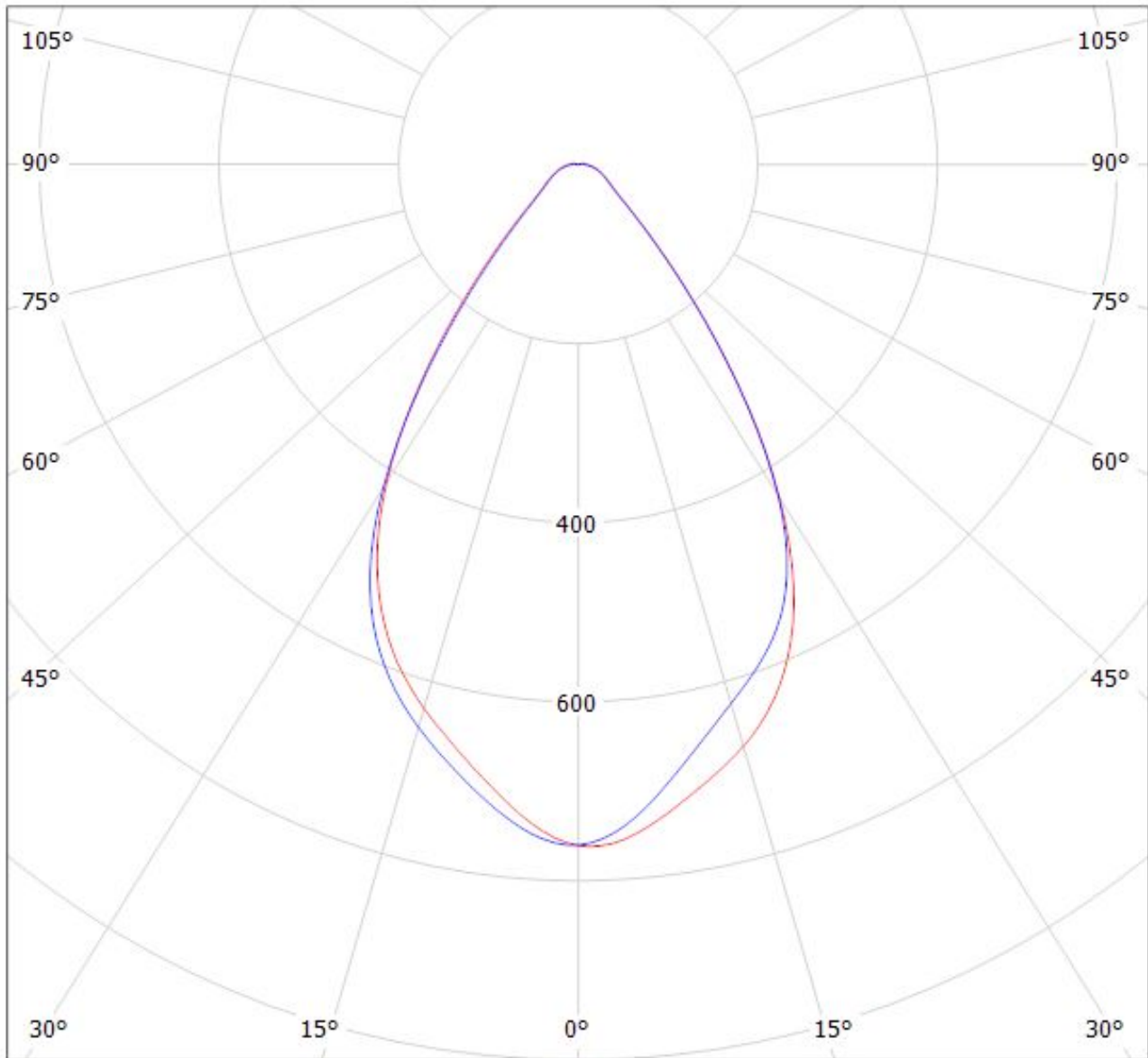

cd/klm

η = 92%

— C0 - C180

— C90 - C270

Luminaire: LEDiL Oy C14606\_HB-2X2-WW\_(XP-L)

Lamps: 1 x Cree\_XP-L\_(XPLAWT-1B0-V40-00-0001)\_496.74lm@250mA\_P=2.80138W\_I=0.2499A

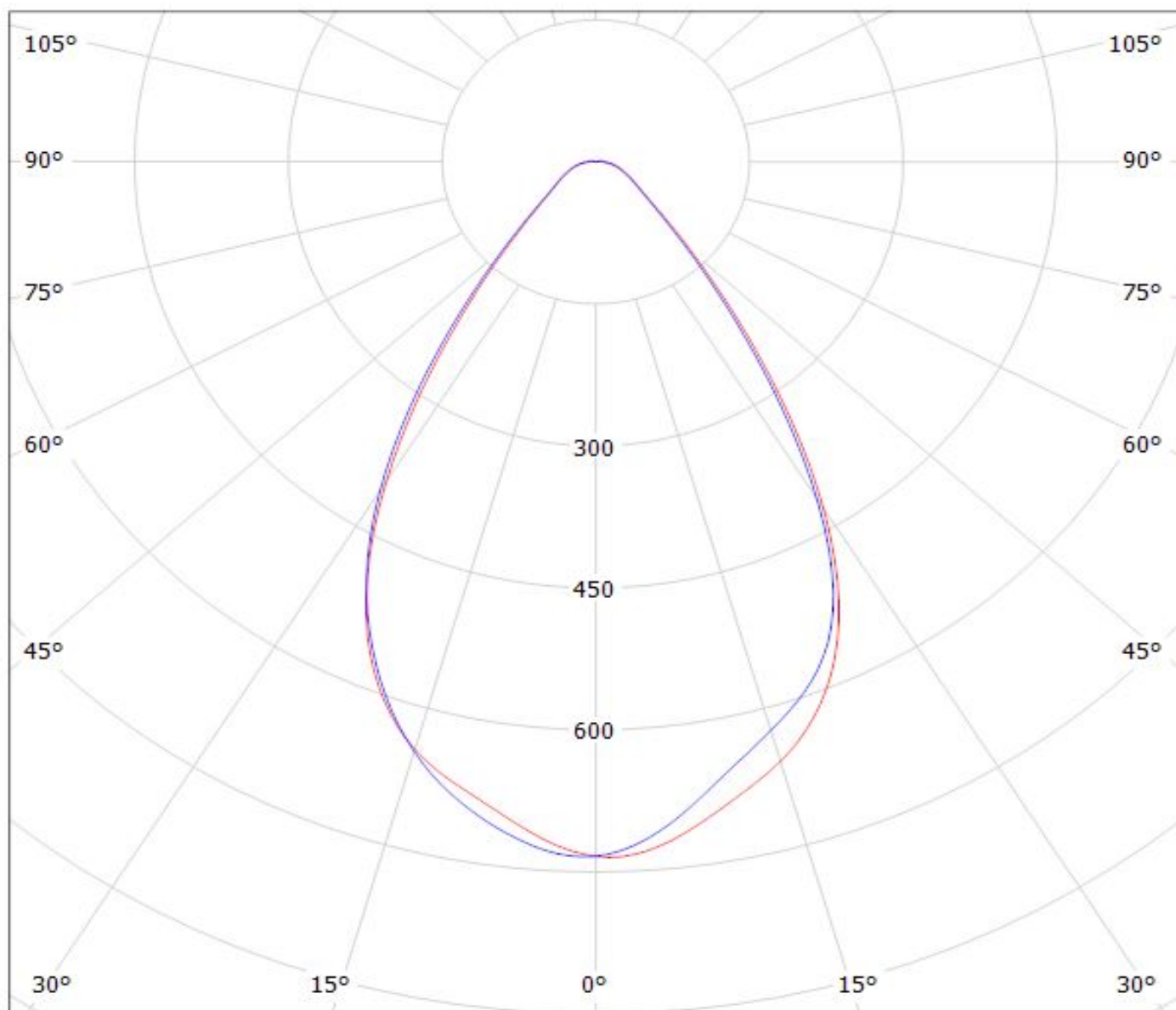

cd/klm

— C0 - C180

— C90 - C270

$\eta = 93\%$

Luminaire: LEDiL Oy C14606\_HB-2X2-WW\_(XM-L2)

Lamps: 1 x Cree\_XM-L2\_2X2\_(XMLBWT-0-7B4-0L-0001)\_354.093lm@250mA\_P=2.81687W\_I=0.2499A

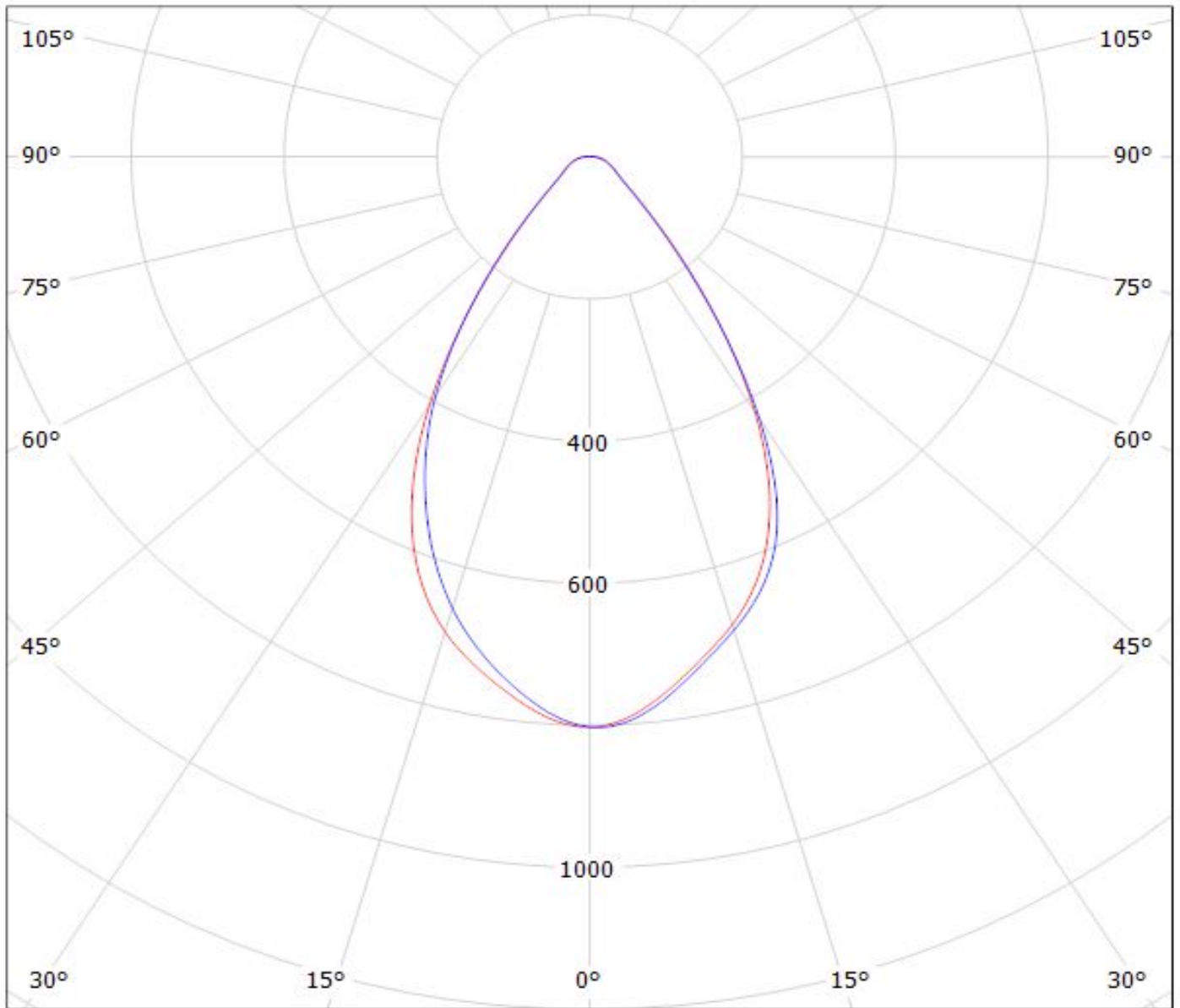

cd/klm

$\eta = 92\%$

— C0 - C180

— C90 - C270

Luminaire: Ledil Oy C14606\_HB-2X2-WW\_(XP-G3)\_SIMULATED  
Lamps: 1 x Cree XP-G3

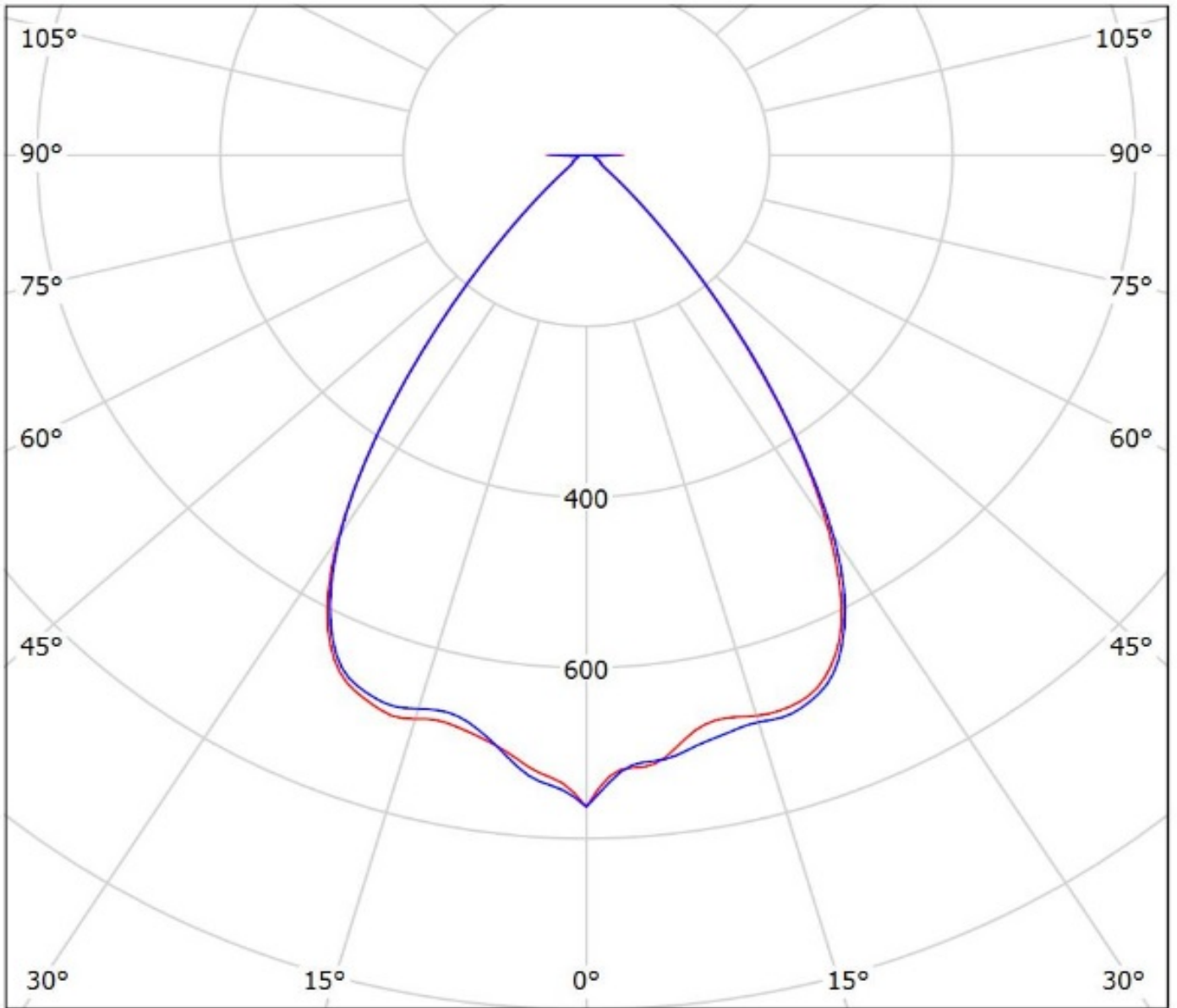

cd/klm  
— C0 - C180 — C90 - C270

$\eta = 95\%$

Luminaire: Ledil C14606\_HB-2X2-WW\_(XP-G2)

Lamps: 2 x Cree\_XP-G2\_2x2\_(XPGBWT-L1-000-00-G51)\_421.786lm@250mA\_P=2.9665W\_I=0.250A - 3.00 W

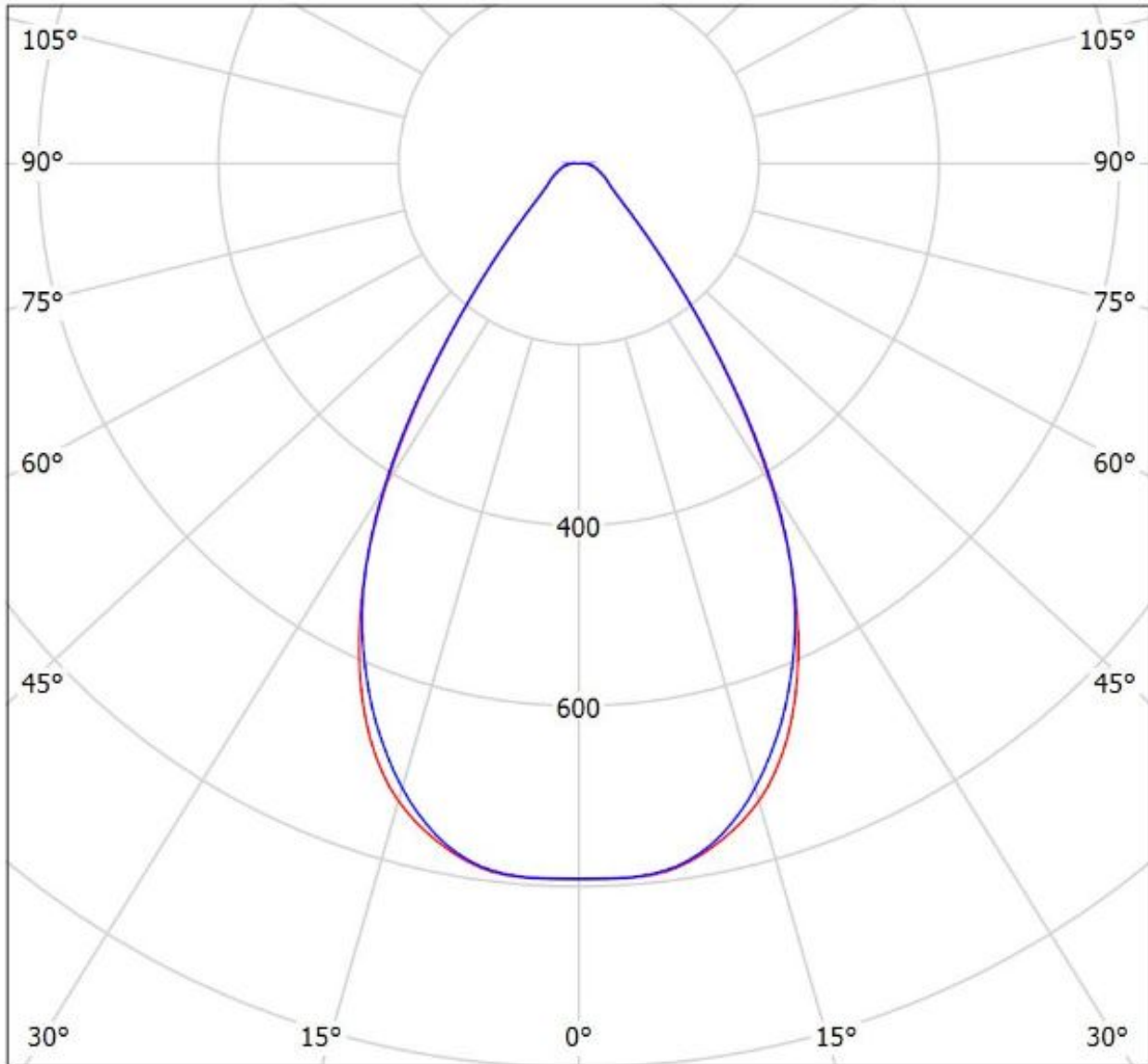

cd/klm

— C0 - C180 — C90 - C270

$\eta = 91\%$



Luminaire: Ledil C14606\_HB-2X2-WW\_(XP-L2)

Lamps: 1 x Cree\_XP-L2\_2x2\_(XPLBWT-00-0000-000BV50E3)550.93lm@250mA\_P=2.7815W\_I=0.25A

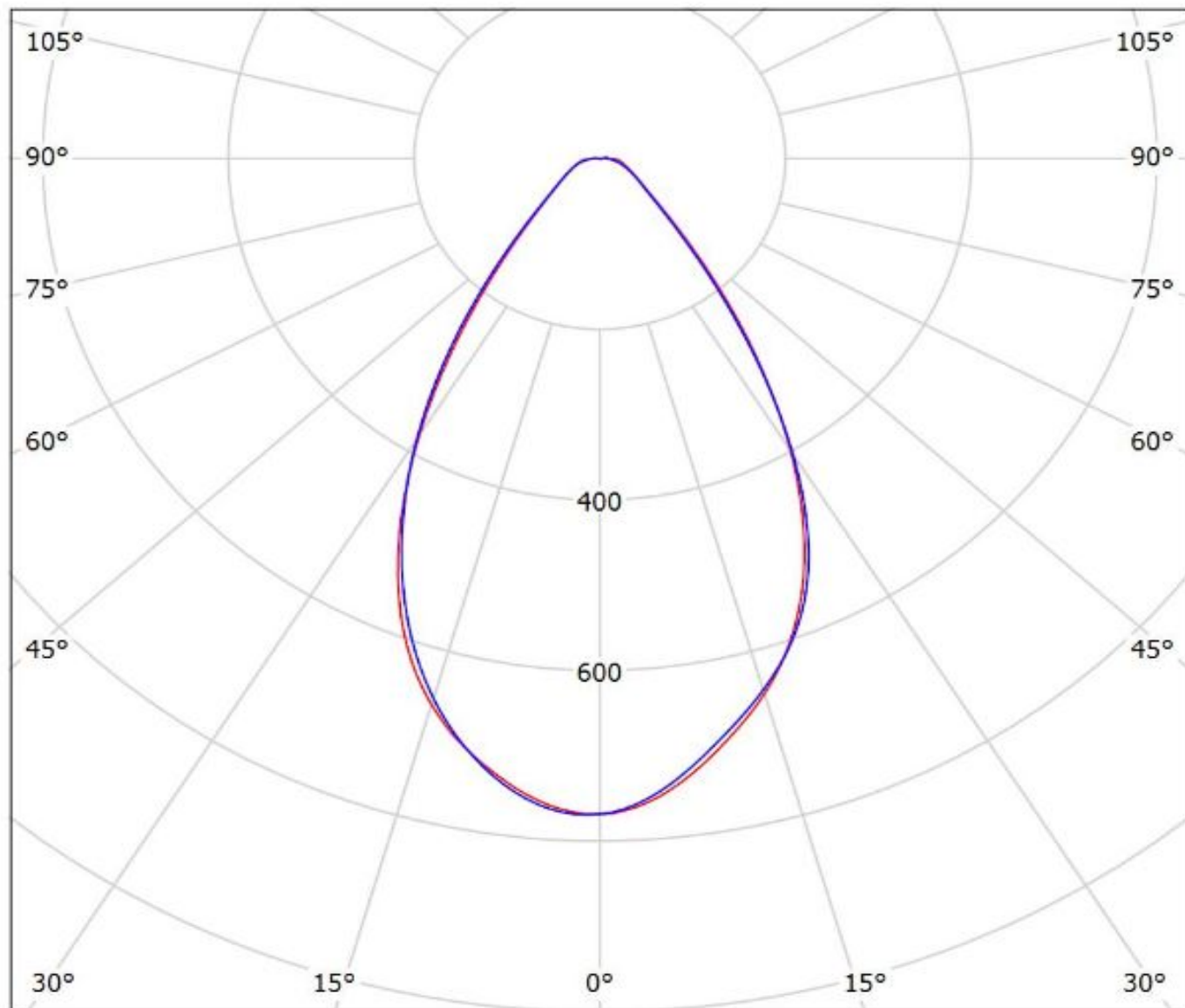

cd/klm

— C0 - C180

— C90 - C270

$\eta = 93\%$

Luminaire: Ledil C14606\_HB-2X2-WW\_(H35C1)

Lamps: 2 x LG\_H35C1\_2x2\_477.216lm@250mA\_P=2.87475W\_I=0.250A

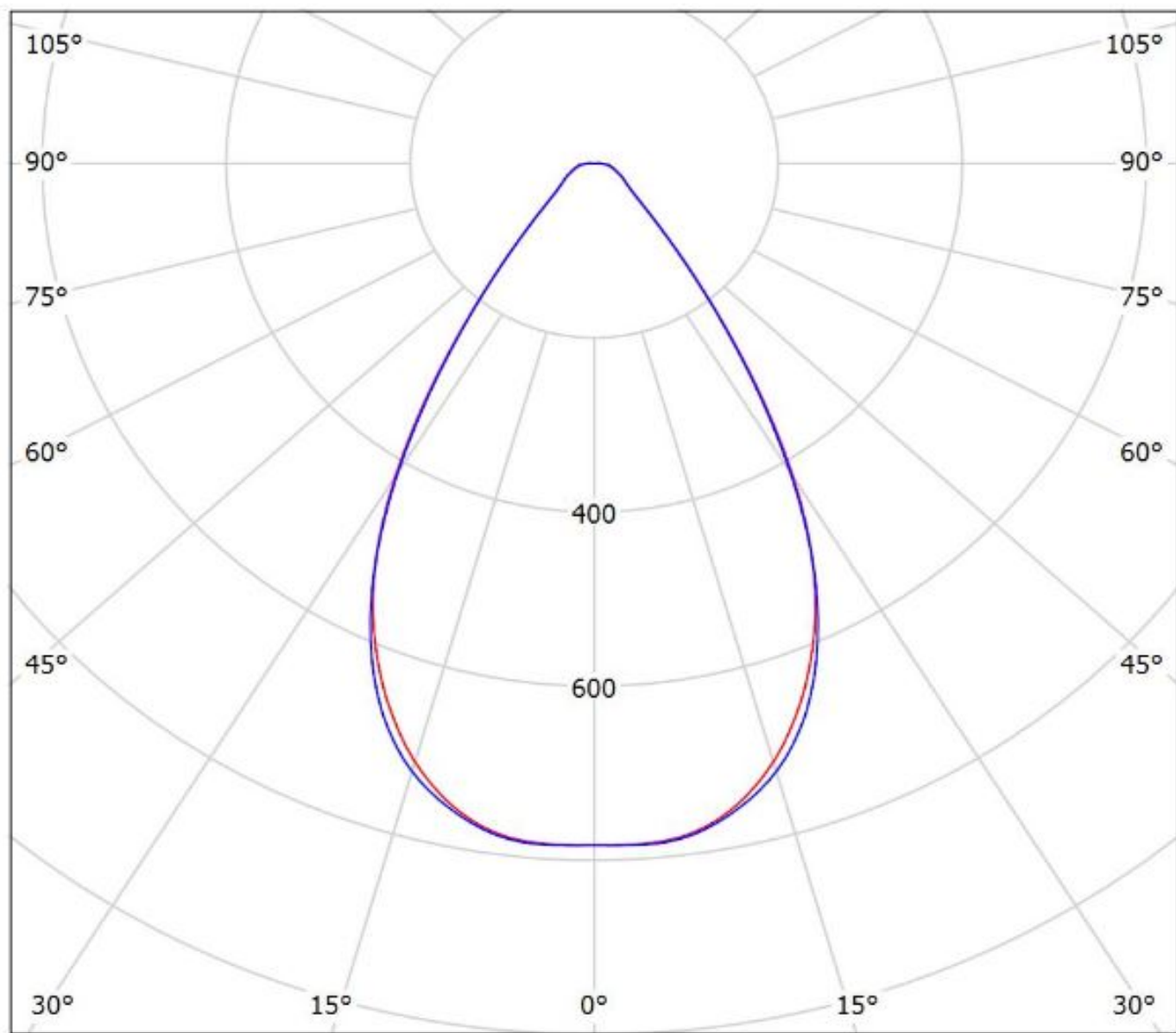

cd/klm

— C0 - C180 — C90 - C270

$\eta = 92\%$



Luminaire: LEDiL Oy C14606\_HB-2X2-WW\_(Luxeon\_5050)

Lamps: 1 x Luxeon\_5050\_2x2\_1270.76lm@80mA\_CCT=5700K\_P=7.35815W\_I=0.080A\_70CRI

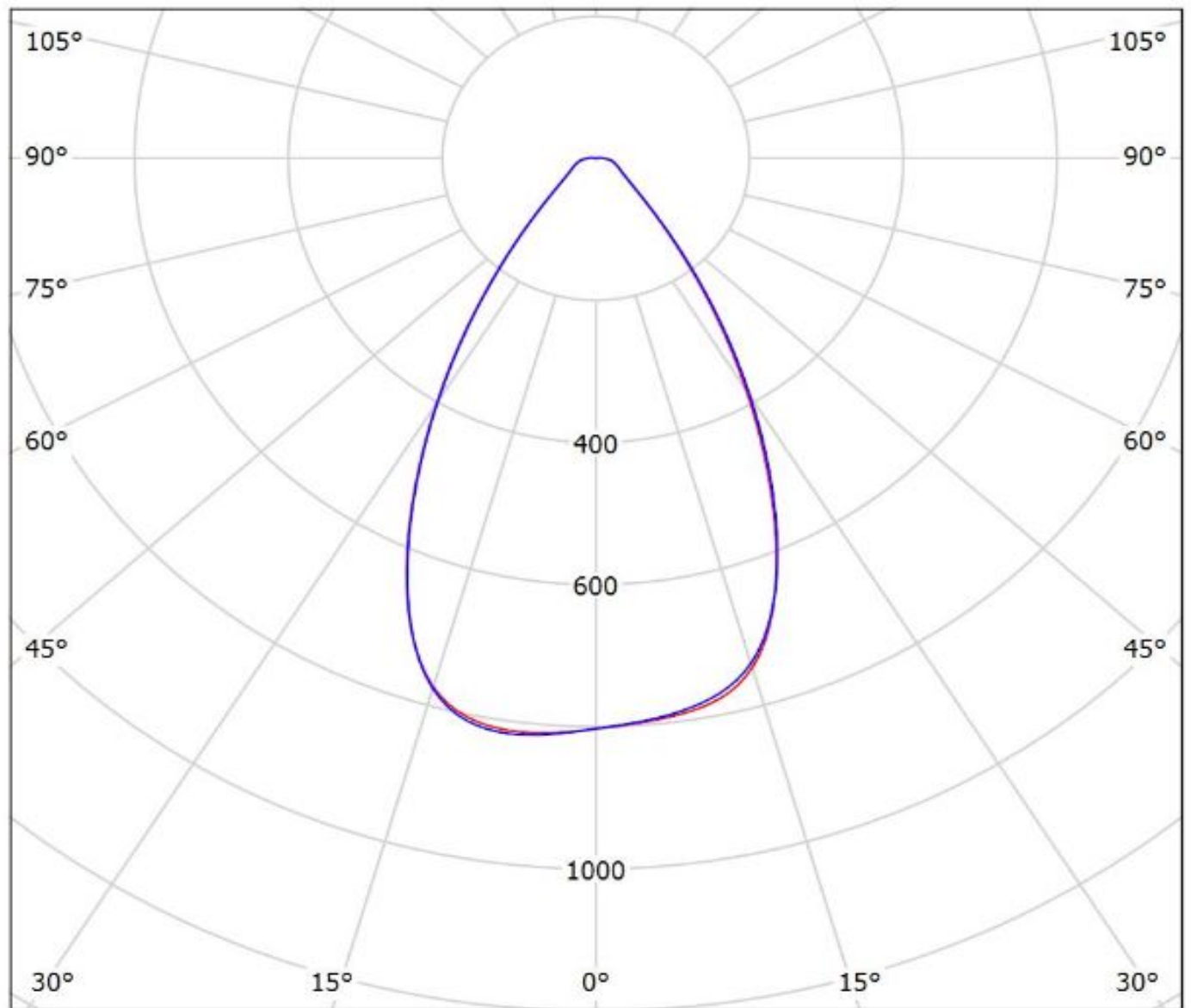

cd/klm

— C0 - C180

— C90 - C270

$\eta = 94\%$

Luminaire: Ledil Oy C14606\_HB-2X2-WW\_(Luxeon\_MZ)\_SIMULATED  
Lamps: 1 x Lumileds Luxeon MZ

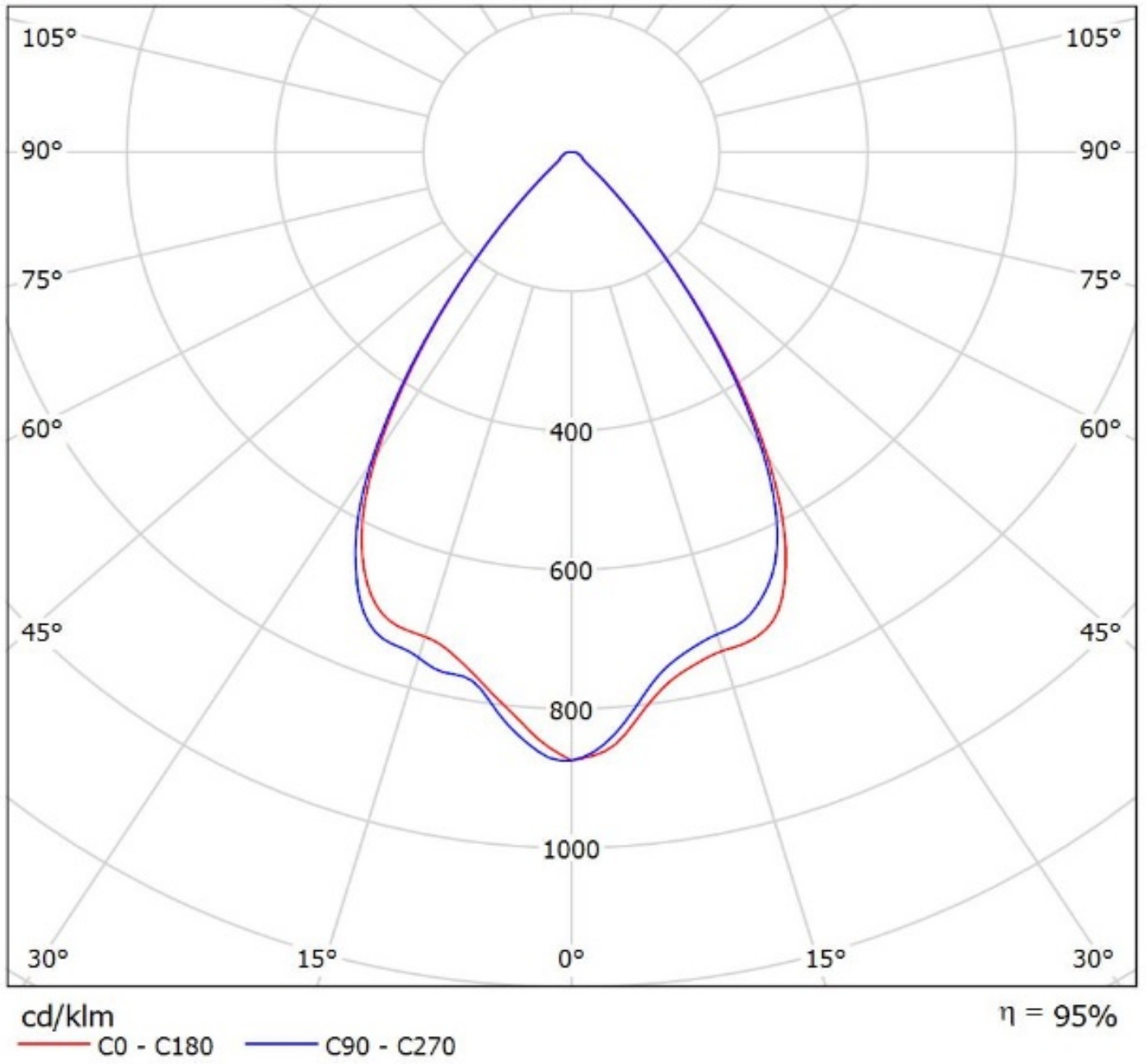

Luminaire: LEDiL Oy C14606\_HB-2X2-WW\_(NWSL229AE)

Lamps: 1 x Nichia\_2X2\_NWSL229AE\_476.548lm@250mA\_P=2.7515W\_I=0.250A

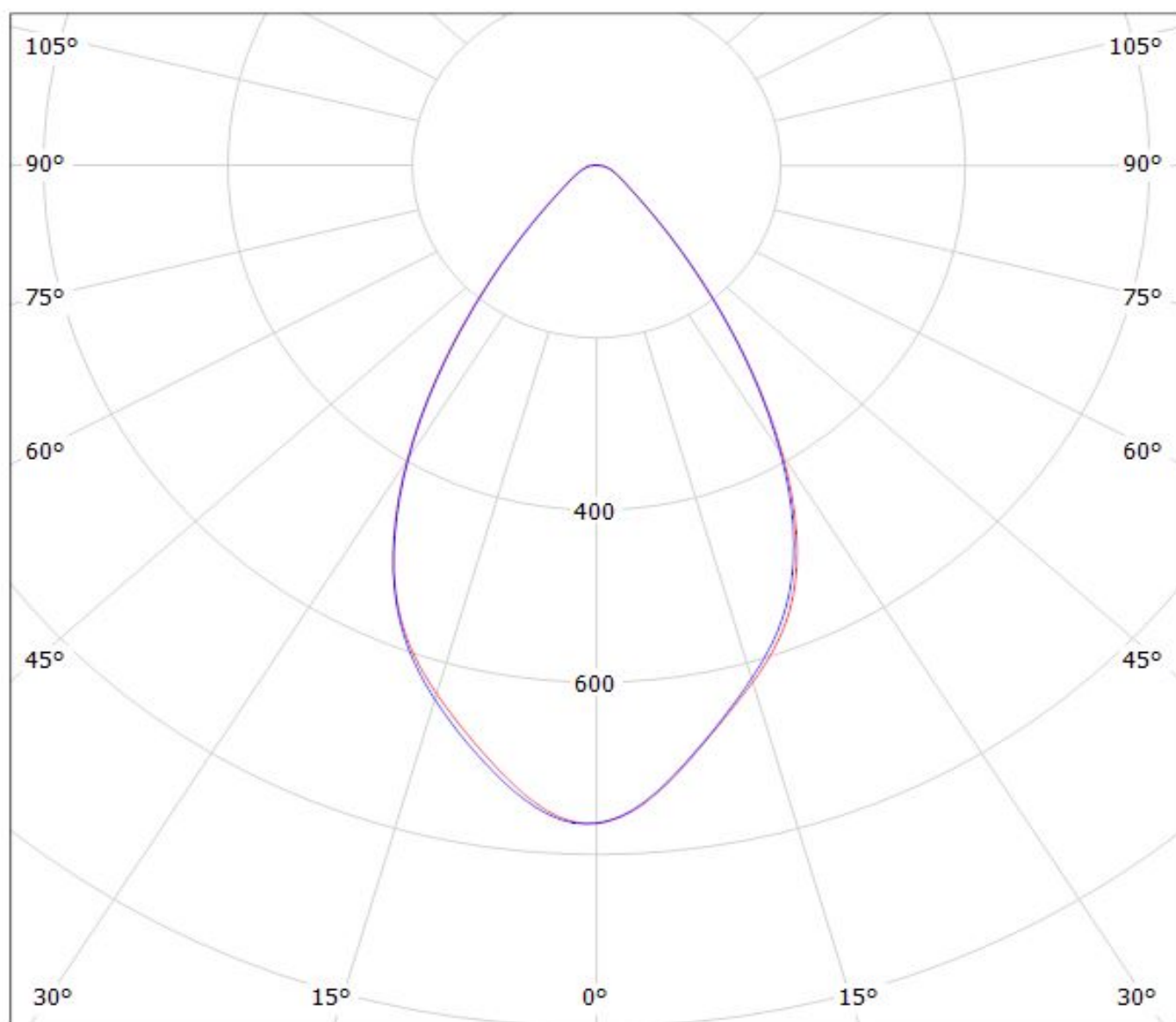

cd/klm

— C0 - C180

— C90 - C270

$\eta = 85\%$

Luminaire: LEDiL Oy C14606\_HB-2X2-WW\_(NVSW319AE)

Lamps: 1 x Nichia\_NVSW319AE\_(sm405D440f2L2R70)\_500.359lm@250mA\_P=2.79351W\_I=0.25A

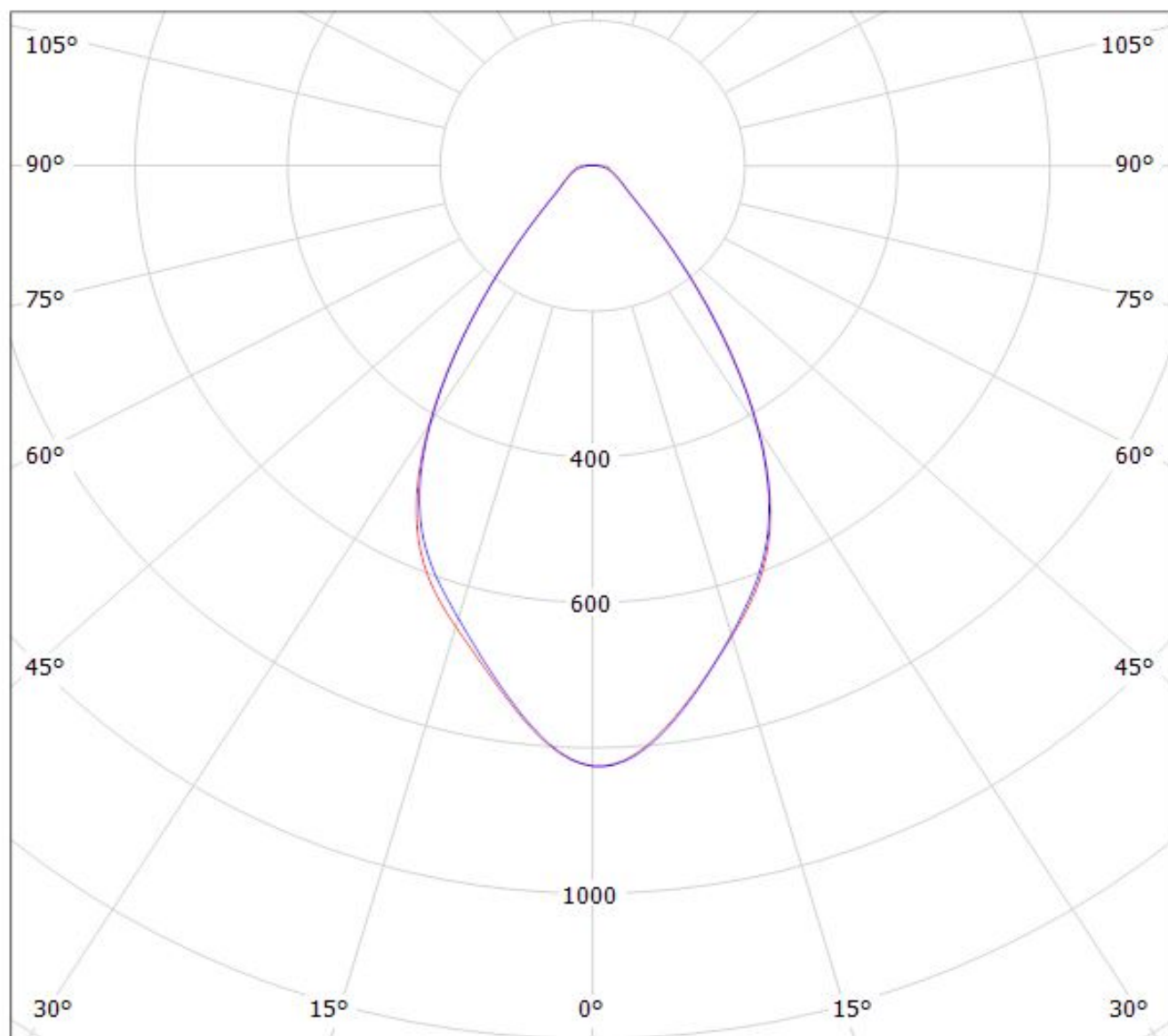

cd/klm

— C0 - C180

— C90 - C270

$\eta = 93\%$

Luminaire: Ledil C14606\_HB-2X2-WW\_(Square\_Gen3)

Lamps: 1 x Osram\_Square\_Gen3\_(GW\_CSSRM2.PM)\_461.082lm@250mA\_P=2.79075W\_I=0.250A

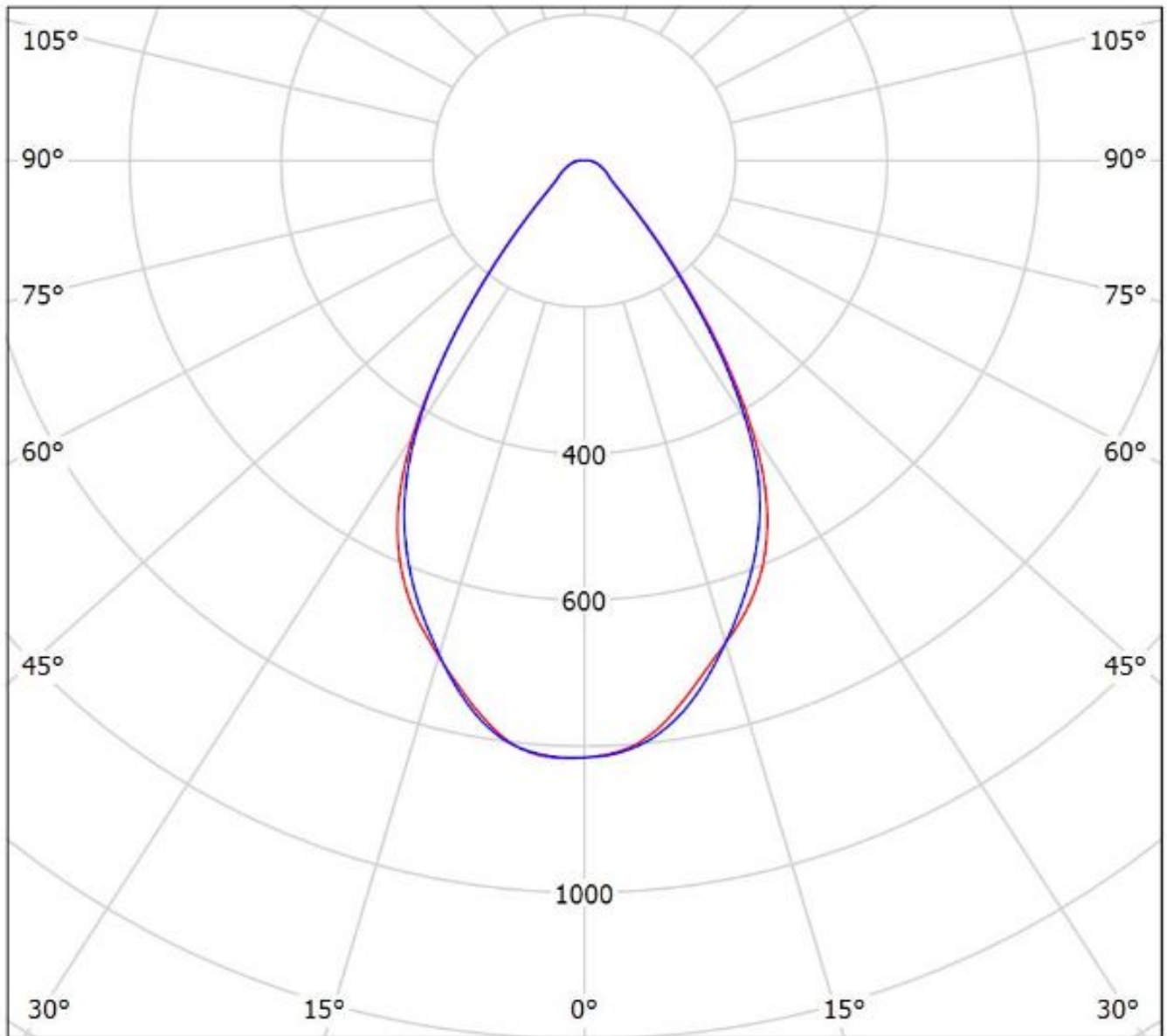

cd/klm

— C0 - C180    — C90 - C270

$\eta = 92\%$

Luminaire: Ledil Oy C14606\_HB-2X2-WW\_OSRAM\_DURIS\_P9\_SIMULATED  
Lamps: 1 x OSRAM DURIS P9

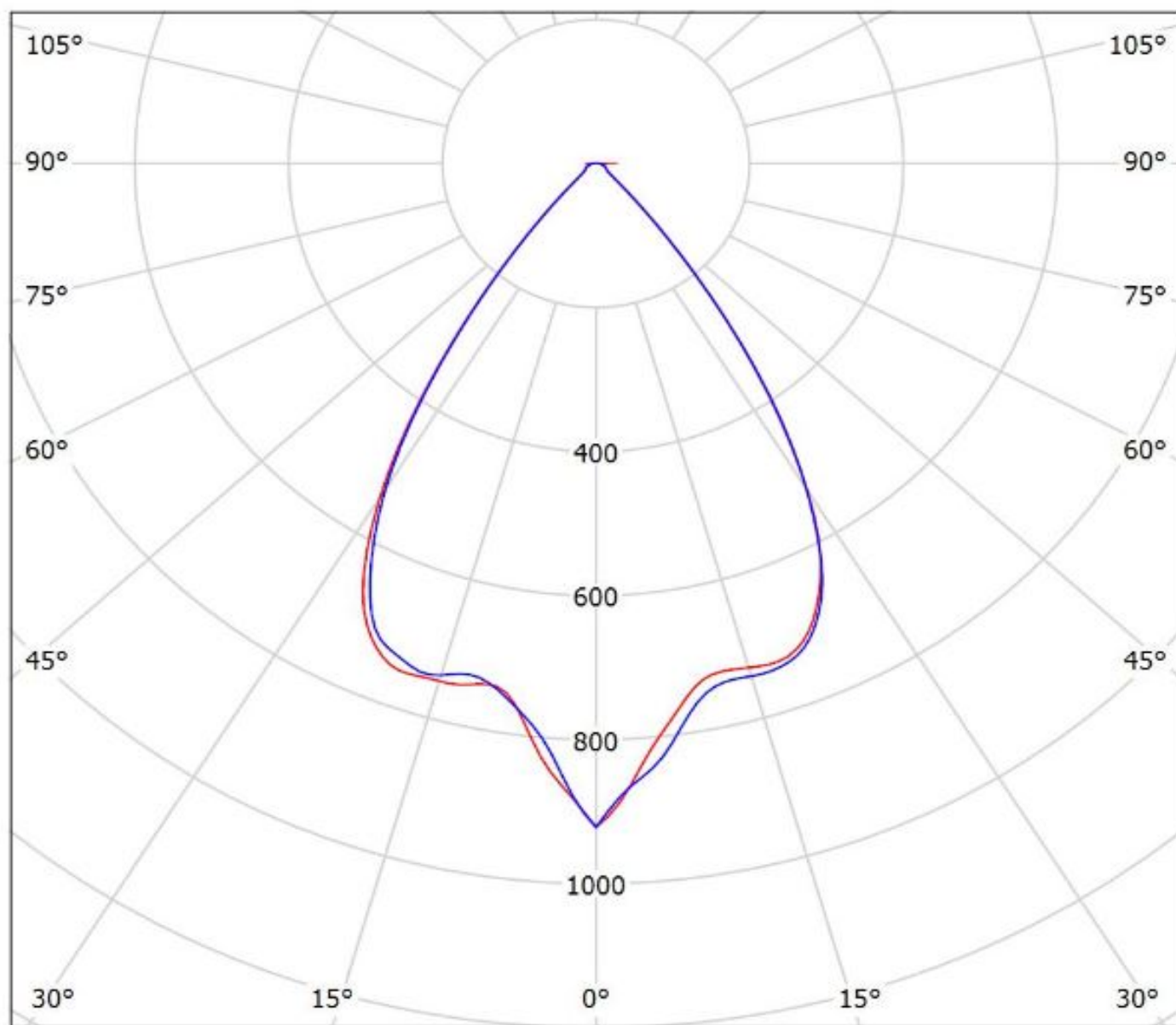

cd/klm

— C0 - C180 — C90 - C270

$\eta = 96\%$



Luminaire: Ledil C14606\_HB-2X2-WW\_(Fortimo\_FastFlex\_LED\_board\_2x8/740\_DA\_G3)  
Lamps: 1 x Fortimo\_FastFlex\_LED\_board\_2x8/740\_DA\_G3\_1823.98lm@250mA\_P=11.65W\_I=0.25A

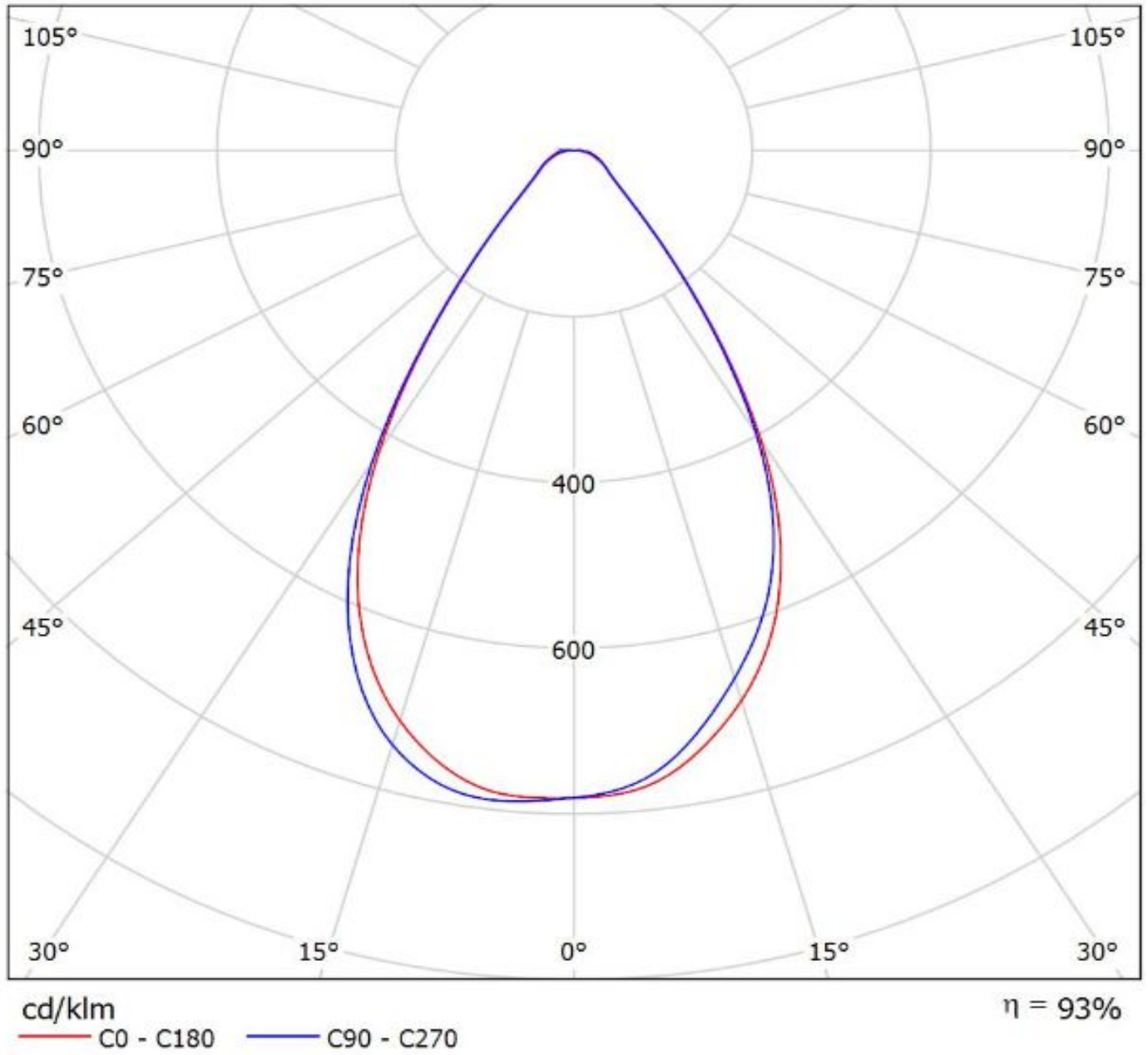

Luminaire: Ledil C14606\_HB-2X2-WW\_(LH351B)

Lamps: 1 x Samsung\_LH351B\_2x2\_444.178lm@250mA\_P=2.8535W\_I=0.25A

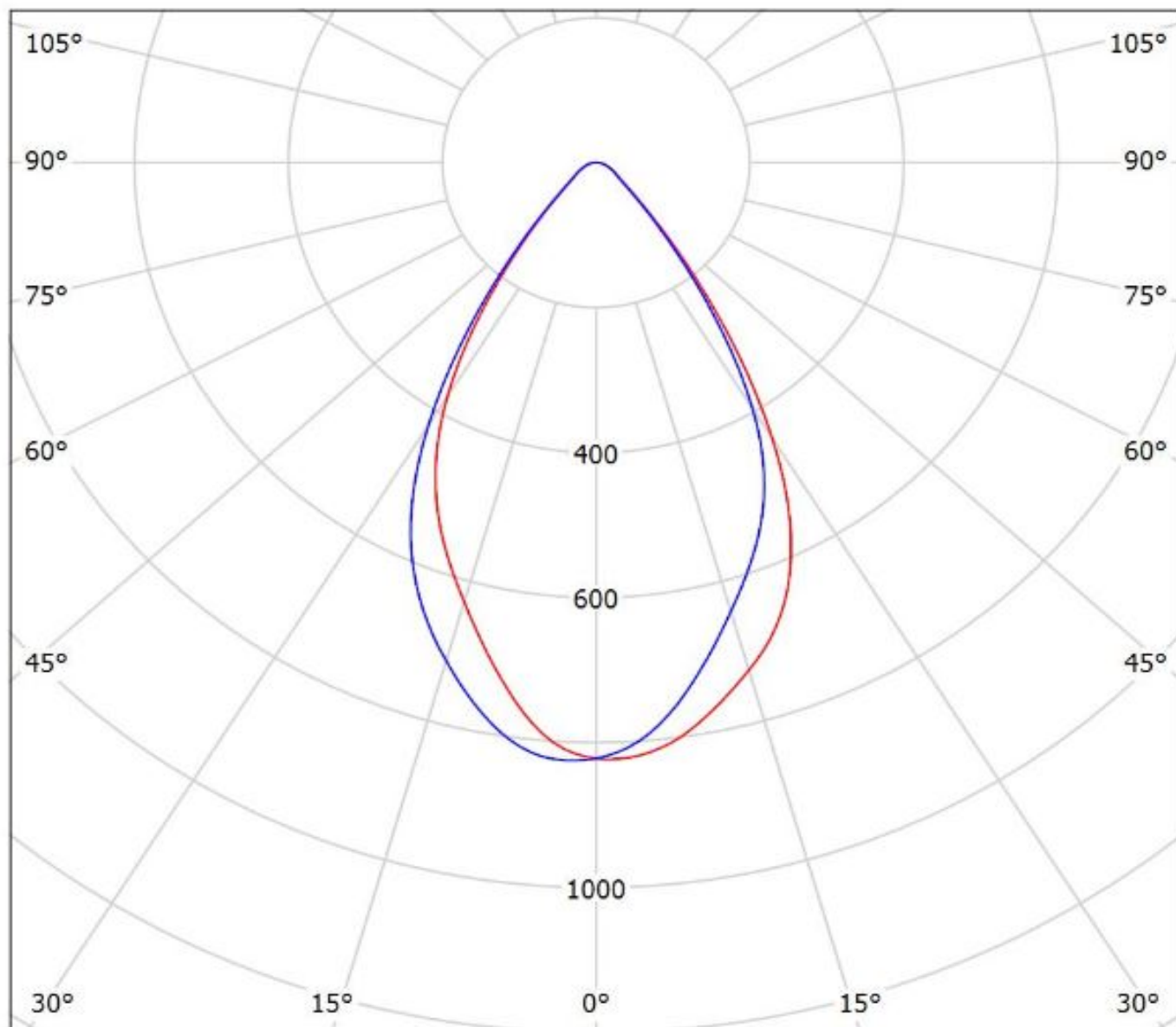

cd/klm

— C0 - C180

— C90 - C270

$\eta = 85\%$



Luminaire: Ledil C14606\_HB-2X2-WW\_(LH351D)

Lamps: 2 x Samsung\_LH351D\_536.957lm@250mA\_P=2.7695W\_I=0.250A

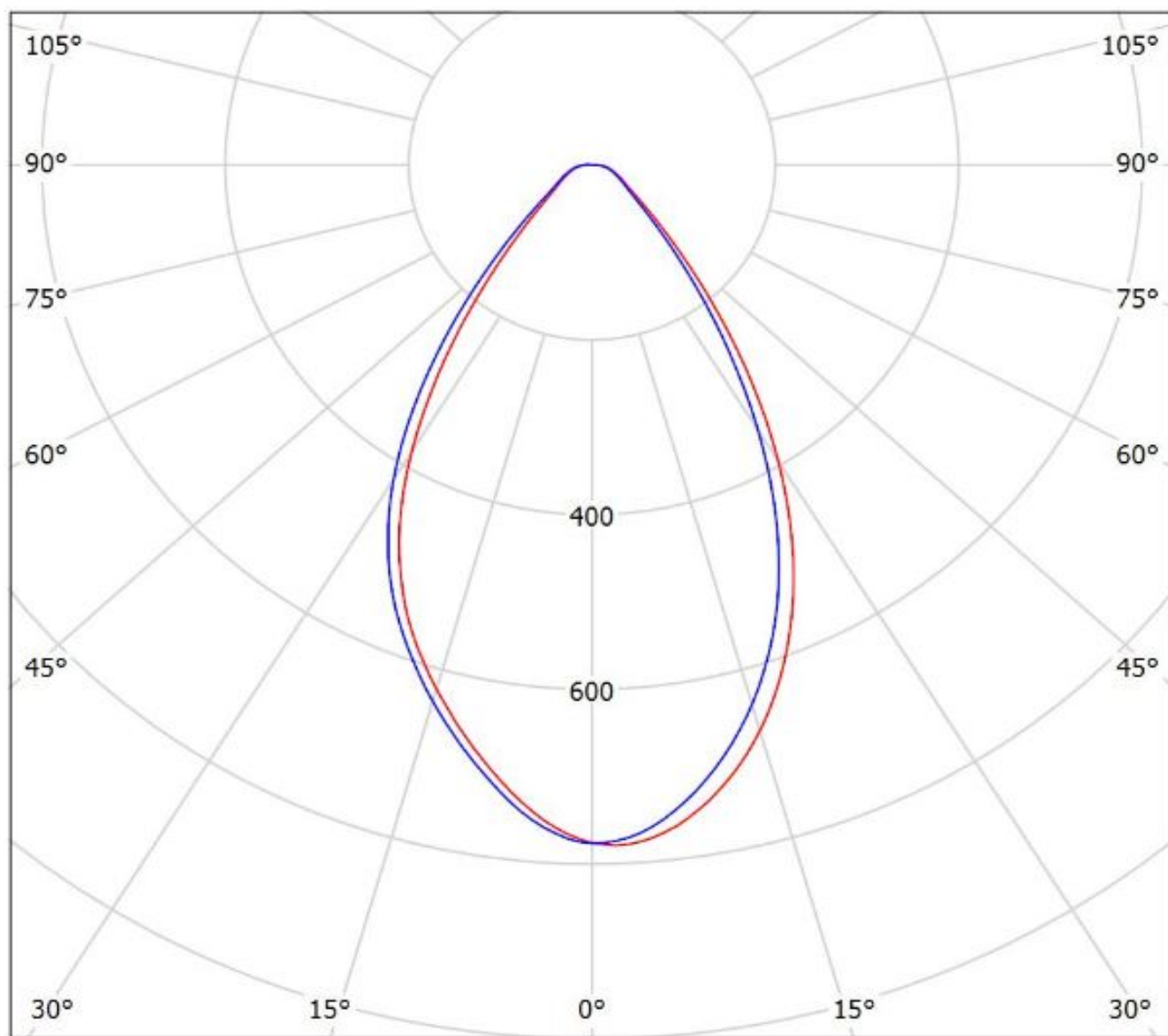

cd/klm

η = 91%

— C0 - C180 — C90 - C270

Luminaire: Ledil C14606\_HB-2X2-WW\_(LH351C)

Lamps: 1 x Samsung\_LH351C\_518.223lm@250mA\_P=2.85225W\_I=0.25A

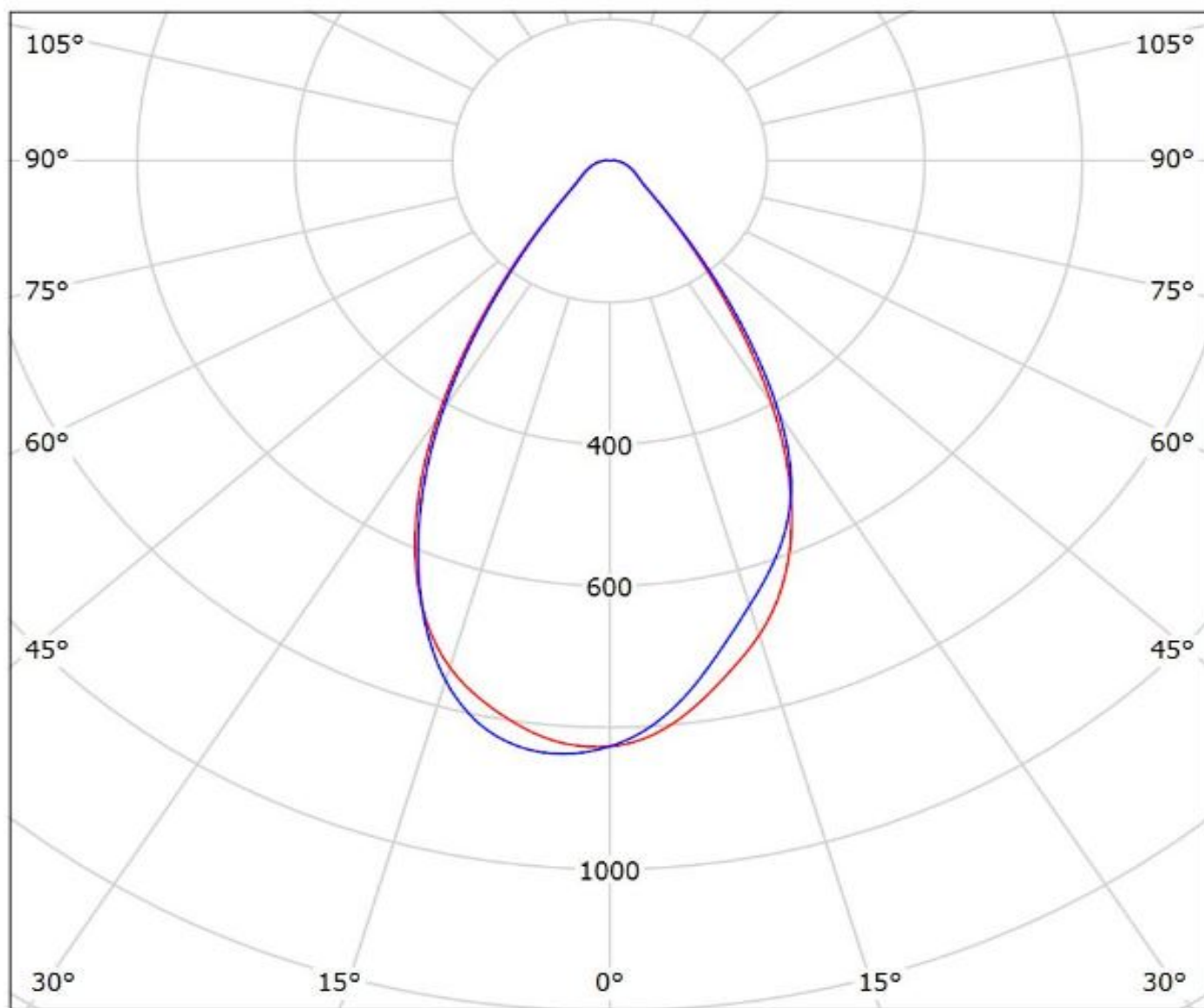

cd/klm

— C0 - C180 — C90 - C270

$\eta = 93\%$

Luminaire: Ledil C14606\_HB-2X2-WW\_(LH508A)

Lamps: 1 x Samsung\_LH508A\_2x2\_2060.04lm@160mA\_CCT=5000K\_CRI=80\_P=15.5405W\_I=0.16A

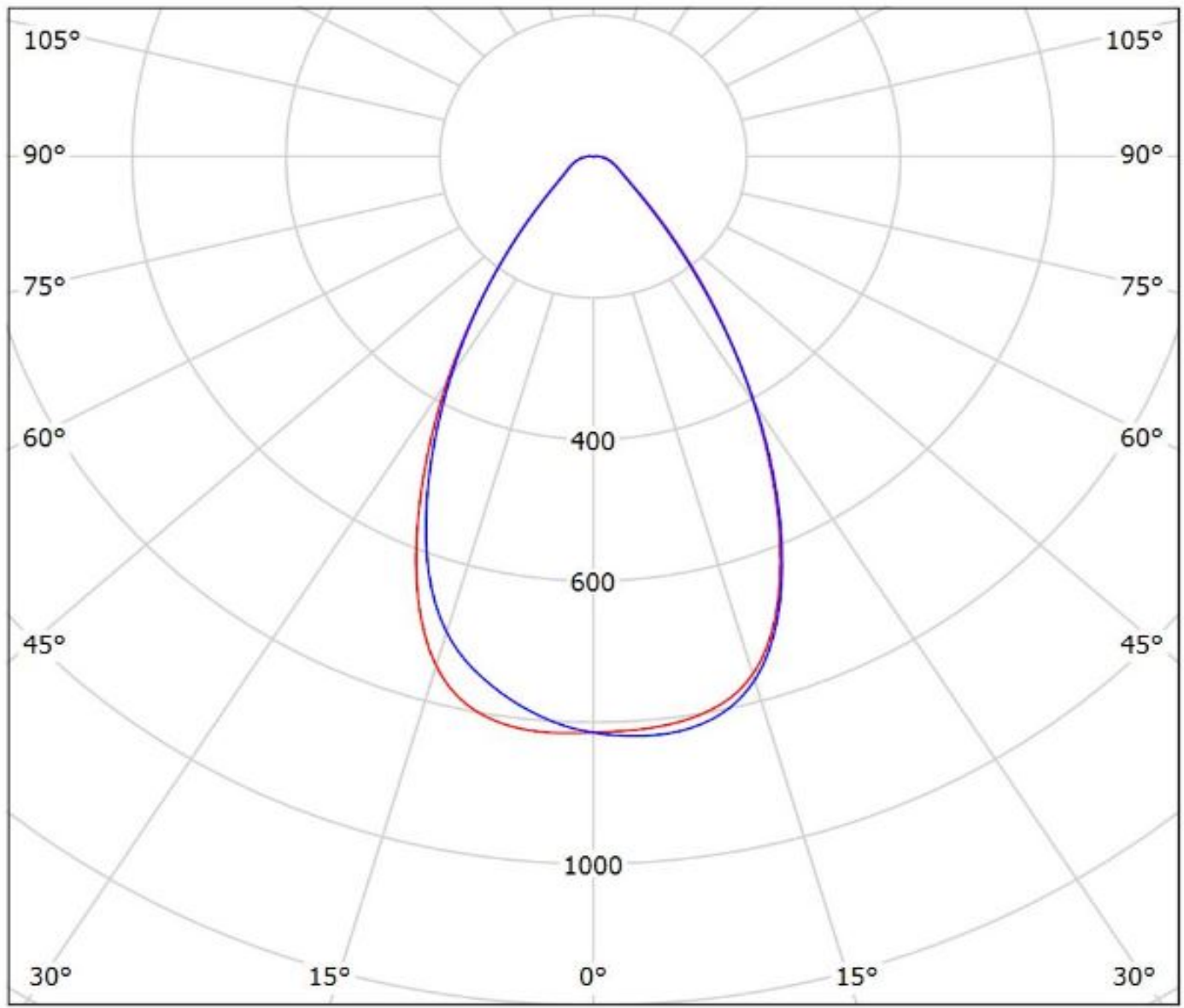

cd/klm

— C0 - C180

— C90 - C270

$\eta = 93\%$

Luminaire: Ledil C14606\_HB-2X2-WW\_(Z8Y22plus)

Lamps: 1 x Seoul\_Z8Y22plus\_(W6E2G)\_513.996lm@250mA\_P=2.754W\_I=0.250A

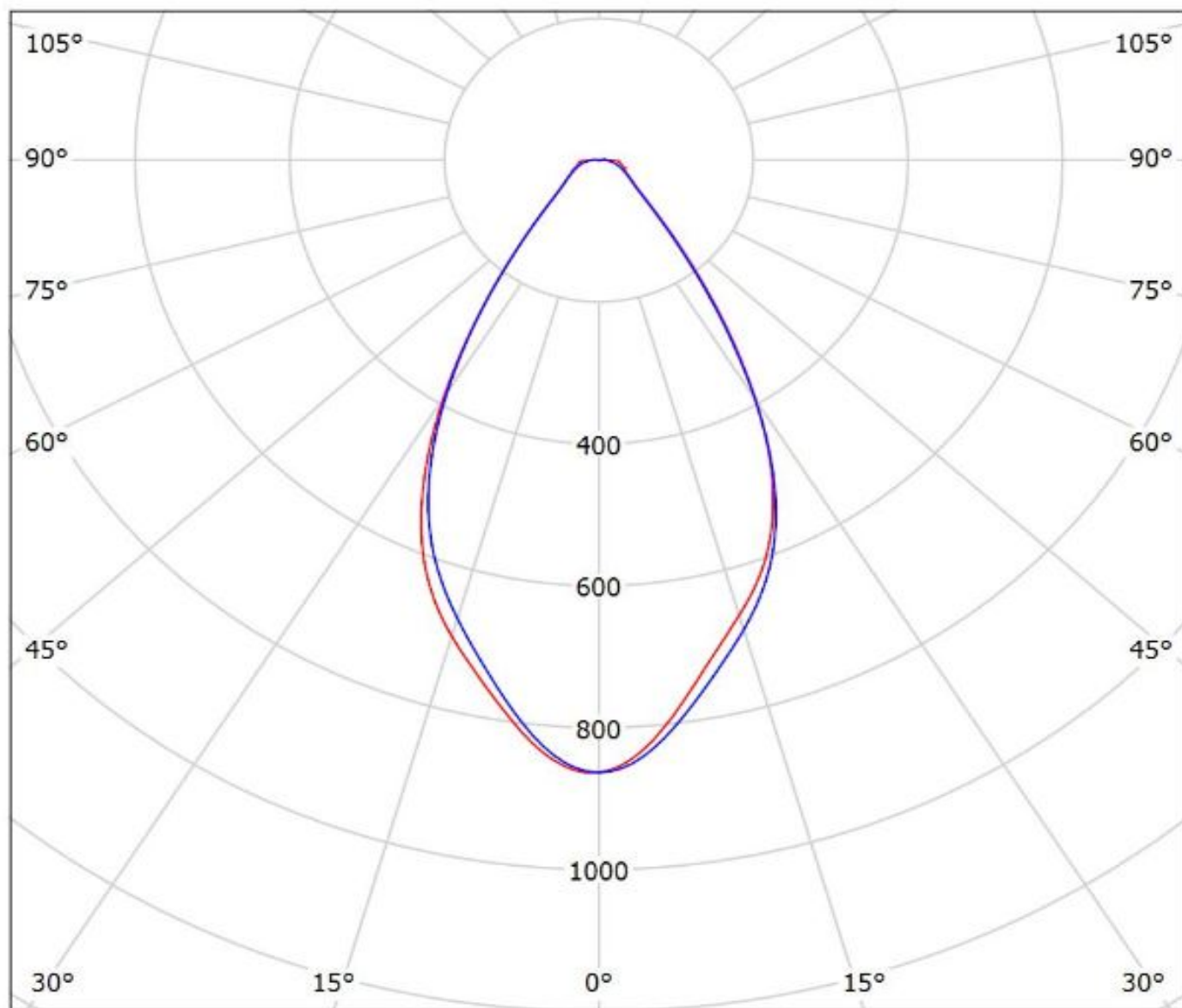

cd/klm

— C0 - C180

— C90 - C270

$\eta = 92\%$

Luminaire: LEDiL Oy C14606\_HB-2X2-WW\_(Tridonic\_Module\_RLE\_G1)

Lamps: 1 x Tridonic\_Module\_RLE\_G1\_4594.42lm@700mA\_P=32.1515W\_I=0.700A

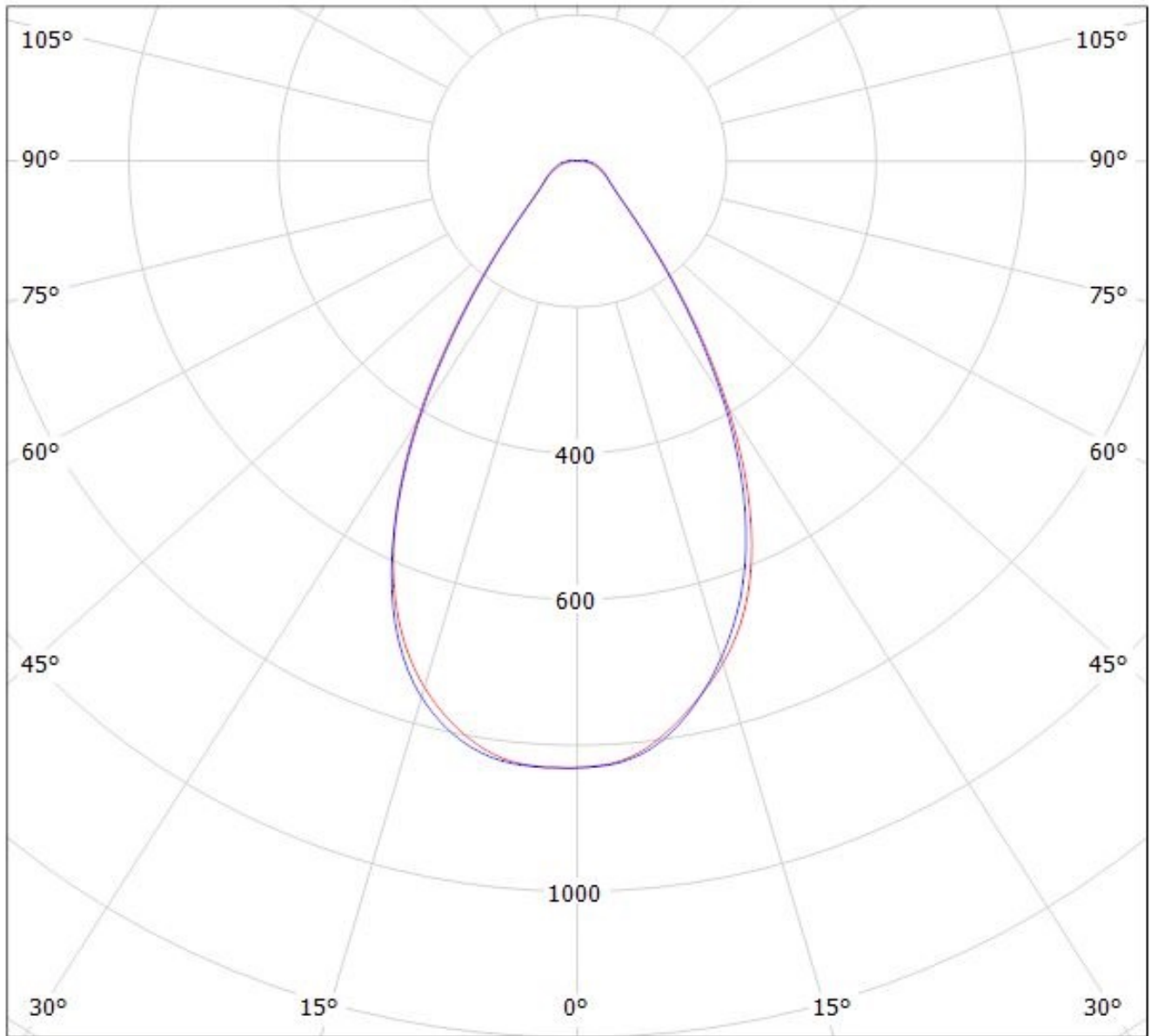

cd/klm

$\eta = 94\%$

— C0 - C180

— C90 - C270

Luminaire: LEDiL Oy C14606\_HB-2X2-WW\_(Tridonic\_Module\_RLE\_G1)

Lamps: 1 x Tridonic\_Module\_RLE\_G1\_4594.42lm@700mA\_P=32.1515W\_I=0.700A

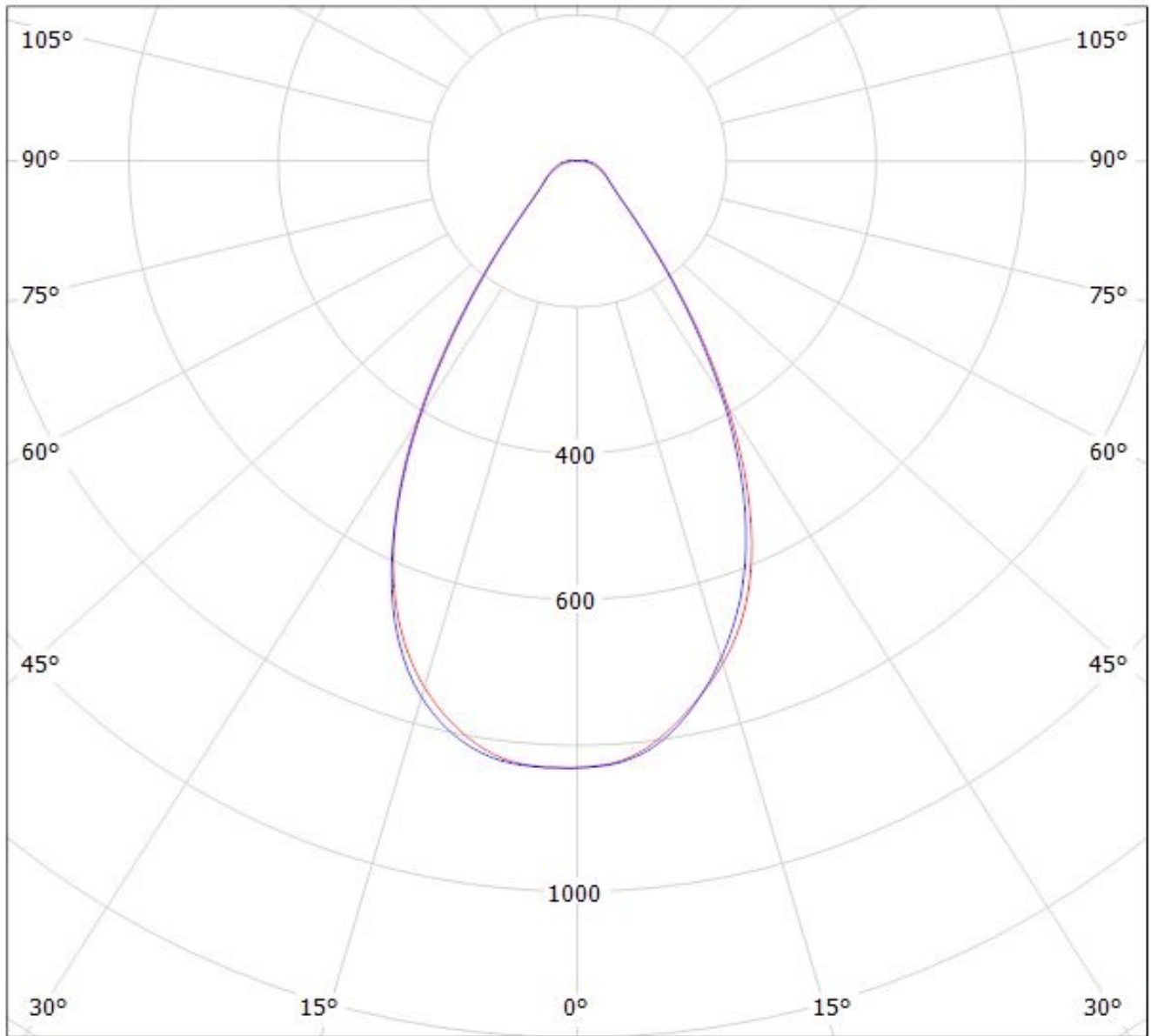

cd/klm

$\eta = 94\%$

— C0 - C180

— C90 - C270



Luminaire: LEDiL Oy C14606\_HB-2X2-WW\_(Tridonic\_Module\_RLE\_G1)  
Lamps: 1 x Tridonic\_Module\_RLE\_G1\_2288lm@700mA\_P=16W\_I=0.700A

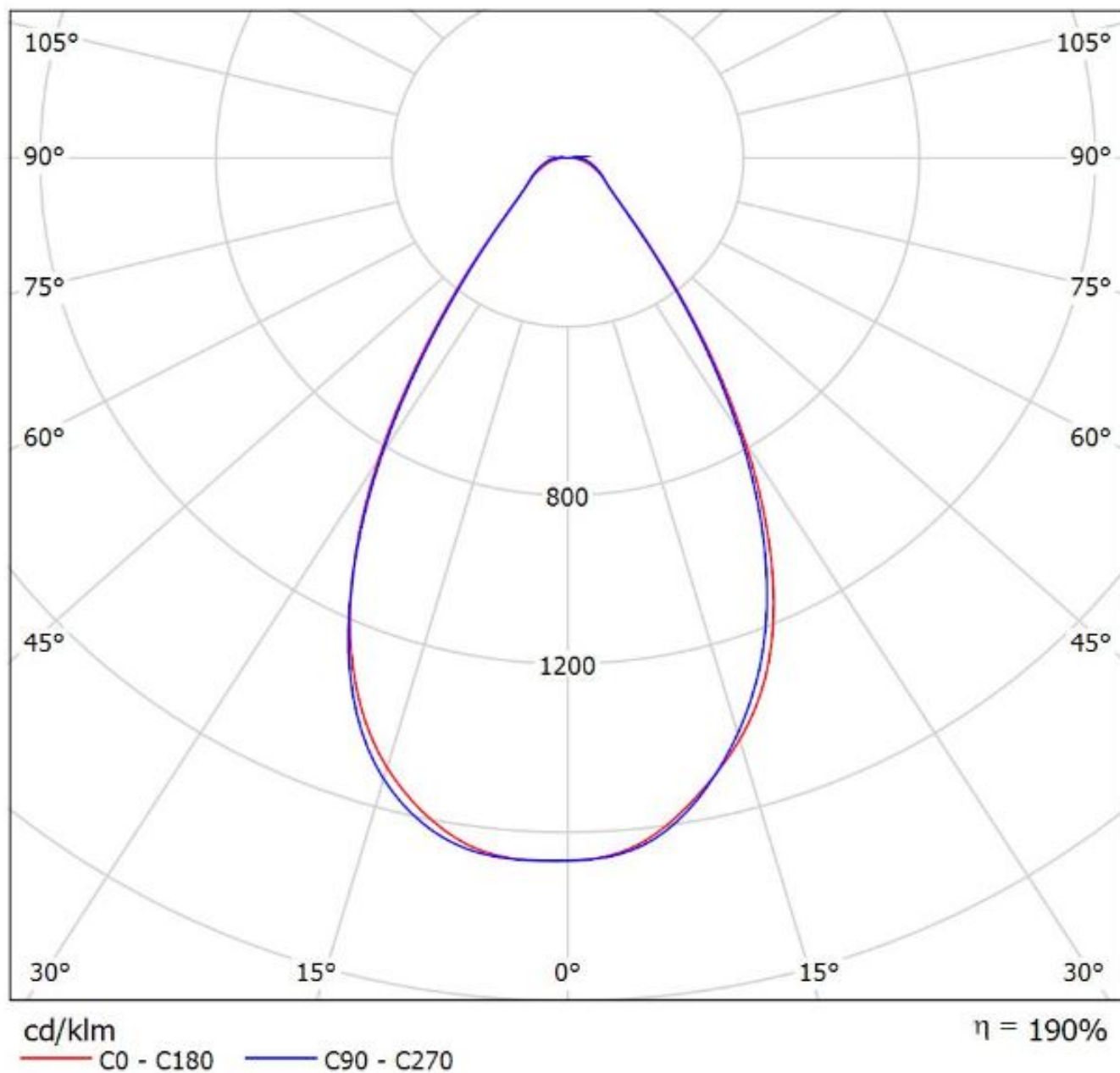

Luminaire: LEDiL Oy C14606\_HB-2X2-WW\_(Tridonic\_Module\_RLE\_G1)  
Lamps: 1 x Tridonic\_Module\_RLE\_G1\_2288lm@700mA\_P=16W\_I=0.700A

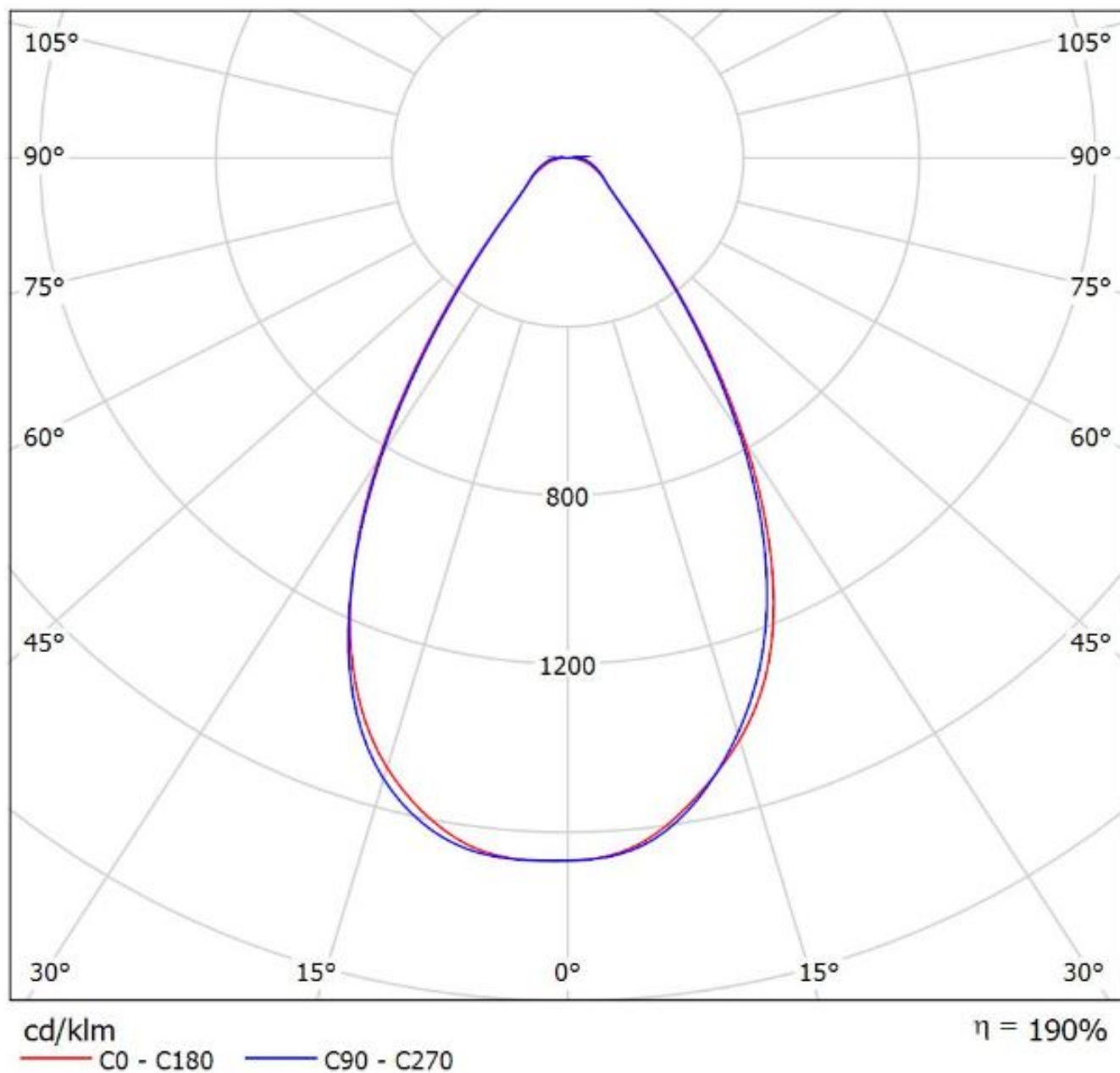



**NOTE: The typical divergence will be changed by different color, chip size and chip position tolerance. The typical total divergence is the full angle measured where the luminous intensity is half of the peak value.**