

## DDR Termination Regulator

### General Description

The RT9040 is a sink/source tracking termination regulator. It is specifically designed for low-cost and low-external component count systems. The RT9040 possesses a high speed operating amplifier that provides fast load transient response and only requires a minimum 20μF of ceramic output capacitance. The RT9040 supports remote sensing functions and all features required to power the DDRI / DDRII / DDRIII and Low Power DDRIII VTT bus termination according to the JEDEC specification. In addition, the RT9040 provides an open drain PGOOD signal to monitor the output regulation and an EN signal that can be used to discharge VTT during S3 (suspend to RAM) for DDR applications .

The RT9040 is available in the thermal efficient WDFN-10L 3x3 package.

### Ordering Information

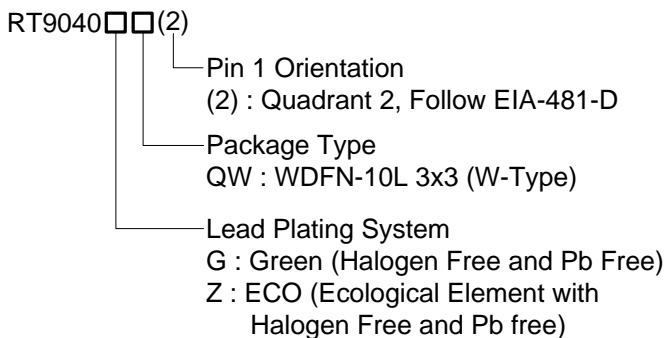

Note :

Richtek products are :

- ▶ RoHS compliant and compatible with the current requirements of IPC/JEDEC J-STD-020.
- ▶ Suitable for use in SnPb or Pb-free soldering processes.

### Features

- $V_{IN}$  Input Voltage Range : 1.1V to 3.5V
- $V_{CNTL}$  Input Voltage Range : 2.375V to 5.5V
- MLCC Stable
- PGOOD to Monitor Output Regulation
- ±10mA Reference (REFOUT)
- Meet DDRI, DDRII JEDEC Spec Supports DDRIII, Low Power DDRIII VTT Application
- Soft Start Function UVLO and OCP
- UVLO and OCP Protection
- Thermal Shutdown
- RoHS Compliant and Halogen Free

### Application

- Notebook/Desktop/Server
- Telecom/Datacom, GSM Base Station, LCD-TV/PDP-TV ,Copier/Printer, Set-Top Box

### Pin Configurations

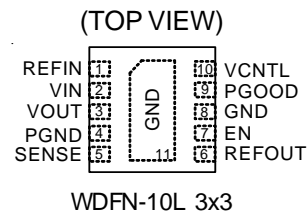

### Marking Information

RT9040GQW(2)

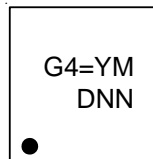

G4= : Product Code  
YMDNN : Date Code

RT9040ZQW(2)

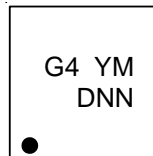

G4 : Product Code  
YMDNN : Date Code

Typical Application Circuit

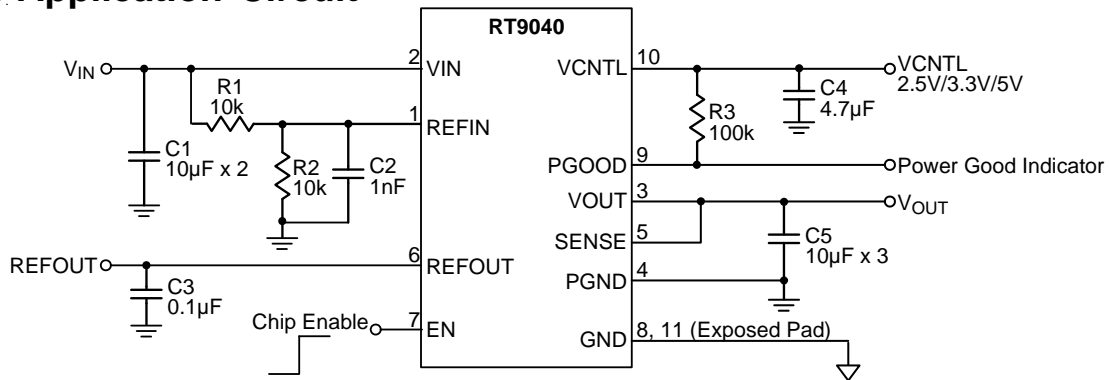

Functional Pin Description

Pin No.	Pin Name	Pin Function
1	REFIN	Reference Input.
2	VIN	Supply Voltage for the LDO.
3	VOUT	Power Output for the LDO.
4	PGND	Power Ground Output for the LDO.
5	SENSE	Voltage Sense Output for the LDO. Connect to positive terminal of the output capacitor or the load.
6	REFOUT	Reference Output. Connect to GND through 0.1uF ceramic capacitor.
7	EN	Chip Enable. For DDR VTT application, connect EN to SLP_S3. For any other application(s), use EN as the ON/OFF function.
8, 11 (Exposed Pad)	GND	Signal Ground. Connect to negative terminal of the output capacitor. The exposed pad must be soldered to a large PCB and connected to GND for maximum power dissipation.
9	PGOOD	PGOOD Output. Indicates regulation. Connect to an internal open drain N-MOSFET.
10	VCNTL	2.5V, 3.3V or 5V power supply. A ceramic decoupling capacitor with a value between 1uF and 4.7uF is required.

Function Block Diagram

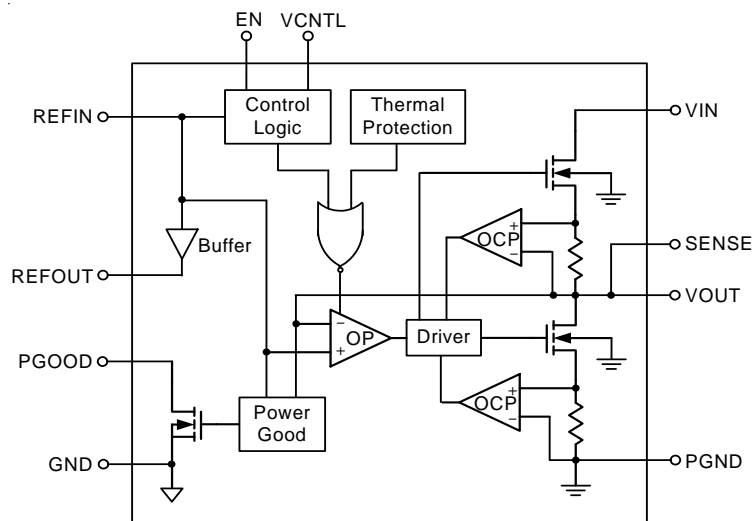

**Absolute Maximum Ratings** (Note 1)

- Supply Input Voltage,  $V_{IN}$ ,  $V_{REFIN}$ ,  $V_{CNTL}$  ----- 6V
- Enable Voltage,  $V_{EN}$  ----- 6V
- Power Dissipation,  $P_D$  @  $T_A = 25^\circ\text{C}$   
 WDFN-10L 3x3 ----- 1.429W
- Package Thermal Resistance (Note 2)  
 WDFN-10L 3x3,  $\theta_{JA}$  -----  $70^\circ\text{C/W}$   
 WDFN-10L 3x3,  $\theta_{JC}$  -----  $8.2^\circ\text{C/W}$
- Lead Temperature (Soldering, 10 sec.) -----  $260^\circ\text{C}$
- Junction Temperature -----  $150^\circ\text{C}$
- Storage Temperature Range -----  $-65^\circ\text{C}$  to  $150^\circ\text{C}$
- ESD Susceptibility (Note 3)  
 HBM (Human Body Model) ----- 2kV  
 MM (Machine Model) ----- 200V

**Recommended Operating Conditions** (Note 4)

- Supply Input Voltage,  $V_{CNTL}$  ----- 2.375V to 5.5V
- Supply Input Voltage,  $V_{IN}$  ----- 1.1V to 3.5V
- Junction Temperature Range -----  $-40^\circ\text{C}$  to  $125^\circ\text{C}$
- Ambient Temperature Range -----  $-40^\circ\text{C}$  to  $85^\circ\text{C}$

**Electrical Characteristics**

( $V_{IN} = 1.8\text{V}$ ,  $V_{EN} = V_{CNTL} = 3.3\text{V}$ ,  $V_{REFIN} = 0.9\text{V}$ ,  $V_{SENSE} = 0.9\text{V}$ ,  $C_{OUT} = 10\mu\text{F} \times 3$ ,  $T_A = 25^\circ\text{C}$ , unless otherwise specification)

Parameter	Symbol	Test Conditions	Min	Typ	Max	Unit
<b>Supply Current</b>						
VCNTL Supply Current	$I_{VCNTL}$	$V_{EN} = 3.3\text{V}$ , No Load	--	0.9	2	mA
VCNTL Shutdown Current	$I_{SHDN\_VCNTL}$	$V_{EN} = 0\text{V}$ , $V_{REFIN} = 0$ , No Load	--	65	80	$\mu\text{A}$
		$V_{EN} = 0\text{V}$ , $V_{REFIN} > 0.4\text{V}$ , No Load	--	200	500	
$V_{IN}$ Supply Current	$I_{VIN}$	$V_{EN} = 3.3\text{V}$ , No Load	--	--	2	mA
$V_{IN}$ Shutdown Current	$I_{SHDN\_VIN}$	$V_{EN} = 0\text{V}$ , No Load	--	0.1	50	$\mu\text{A}$
<b>Input Current</b>						
REFIN Input Current	$I_{REFIN}$	$V_{EN} = 3.3\text{V}$	--	--	1	$\mu\text{A}$
<b>Output</b>						
Offset Voltage of Output DC Voltage	$V_{VOTOL}$	$V_{IN} = 2.5\text{V}$ , $V_{REFOUT} = 1.25\text{V}$ (DDR1), $I_{OUT} = 0\text{A}$	--	1.25	--	V
			-10	--	10	mV
		$V_{IN} = 1.8\text{V}$ , $V_{REFOUT} = 0.9\text{V}$ (DDR2), $I_{OUT} = 0\text{A}$	--	0.9	--	V
			-10	--	10	mV
$V_{IN} = 1.5\text{V}$ , $V_{REFOUT} = 0.75\text{V}$ (DDR3), $I_{OUT} = 0\text{A}$	--	0.75	--	V		
	-10	--	10	mV		
VOUT Load Regulation	$\Delta V_{LOAD}$	$-2\text{A} < I_{OUT} < 2\text{A}$	-15	--	15	mV

Parameter	Symbol	Test Conditions	Min	Typ	Max	Unit
VOUT Source Current Limit	$I_{LIM\_VOUT\_sr}$	$V_{CNTL} = 5V$ ( $V_{OUT}$ in PGOOD window)	3.5	--	5.5	A
VOUT Sink Current Limit	$I_{LIM\_VOUT\_sk}$	$V_{CNTL} = 5V$ ( $V_{OUT}$ in PGOOD window)	3.5	--	5.5	A
VOUT Discharge Resistance	$R_{DISCHARGE}$	$V_{REFIN} = 0V$ , $V_{OUT} = 0.3V$ , $V_{EN} = 0V$	--	18	25	$\Omega$
<b>Power Good Comparator</b>						
VOUT PGOOD Threshold	$V_{TH\_PGOOD}$	PGOOD window lower threshold with respect to REFOUT	-23.5	-20	-17.5	%
		PGOOD Hysteresis	--	5	--	
PGOOD Startup Delay	$T_{pgdelay1}$	Startup rising edge, $V_{SENSE}$ within 15% of REFOUT	--	2	--	ms
Output Low Voltage	$V_{LOW\_PGOOD}$	$I_{SINK} = 4mA$	--	--	0.4	V
PGOOD Bad Delay	$T_{pgdealy2}$	$V_{SENSE}$ is outside of the $\pm 20\%$ PGOOD window	--	10	--	$\mu s$
Leakage Current	$I_{LEAKAGE\_PGOOD}$	$V_{SENSE} = V_{REFIN}$ (PGOOD high impedance), PGOOD = $V_{CNTL} + 0.2V$	--	--	1	$\mu A$
<b>REFIN and REFOUT</b>						
REFIN Voltage Range	$V_{REFIN}$		0.5	--	1.8	V
REFIN Under Voltage Lockout	$V_{UVLO\_REFIN}$	REFIN Rising	360	390	420	mV
		Hysteresis	--	20	--	
REFOUT Voltage Tolerance to VREFIN	$V_{TOL\_REFOUT}$	$-10mA < I_{REFOUT} < 10mA$ , $V_{REFIN} = 1.25V$	-15	--	15	mV
		$-10mA < I_{REFOUT} < 10mA$ , $V_{REFIN} = 0.9V$	-15	--	15	
		$-10mA < I_{REFOUT} < 10mA$ , $V_{REFIN} = 0.75V$	-15	--	15	
REFOUT Source Current Limit	$I_{LIM\_REFOUT\_sr}$	$V_{REFOUT} = 0V$	10	40	--	mA
REFOUT Sink Current Limit	$I_{LIM\_REFOUT\_sk}$	$V_{REFOUT} = V_{IN}$	10	40	--	mA
<b>UVLO / EN Logic Threshold</b>						
UVLO Threshold	$V_{UVLO\_VCNTL}$	Wake up	2.2	2.3	2.375	V
		Hysteresis	--	50	--	mV
High-Level Input Voltage	$V_{IN\_H}$	Enable	1.7	--	--	V
Low-Level Input Voltage	$V_{IN\_L}$	Enable	--	--	0.3	V
Hysteresis Voltage	$V_{EN\_hys}$	Enable	--	0.5	--	V
Logic Input Leakage Current	$I_{LEAKAGE\_EN}$	Enable	-1	--	1	$\mu A$
<b>Thermal Shutdown</b>						
Thermal Shutdown Threshold	$T_{SD}$	Shutdown Temperature	--	160	--	$^{\circ}C$
		Hysteresis	--	25	--	

**Note 1.** Stresses beyond those listed “Absolute Maximum Ratings” may cause permanent damage to the device. These are stress ratings only, and functional operation of the device at these or any other conditions beyond those indicated in the operational sections of the specifications is not implied. Exposure to absolute maximum rating conditions may affect device reliability.

**Note 2.**  $\theta_{JA}$  is measured at  $T_A = 25^\circ\text{C}$  on a high effective thermal conductivity four-layer test board per JEDEC 51-7.  $\theta_{JC}$  is measured at the exposed pad of the package.

**Note 3.** Devices are ESD sensitive. Handling precaution is recommended.

**Note 4.** The device is not guaranteed to function outside its operating conditions.

## Typical Operating Characteristics

**Supply Current vs. Temperature**

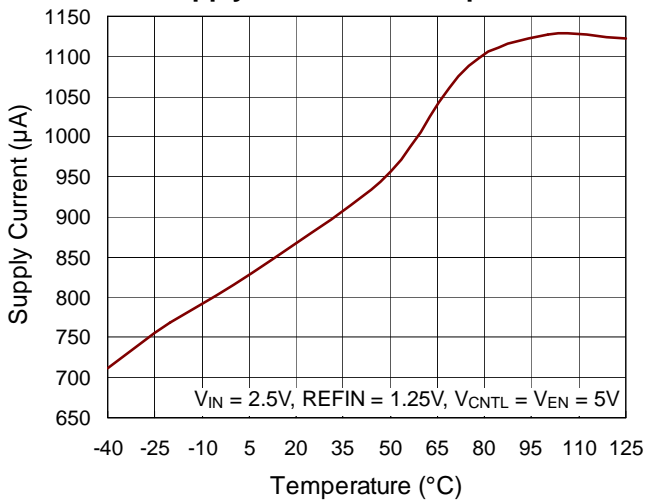

**Shutdown Current vs. Temperature**

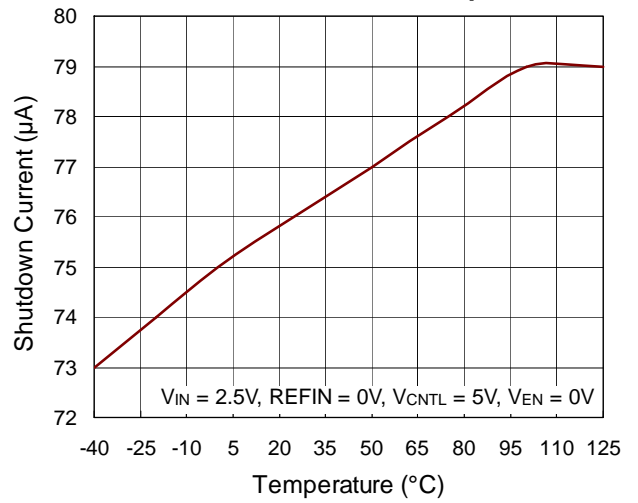

**Standby Current vs. Temperature**

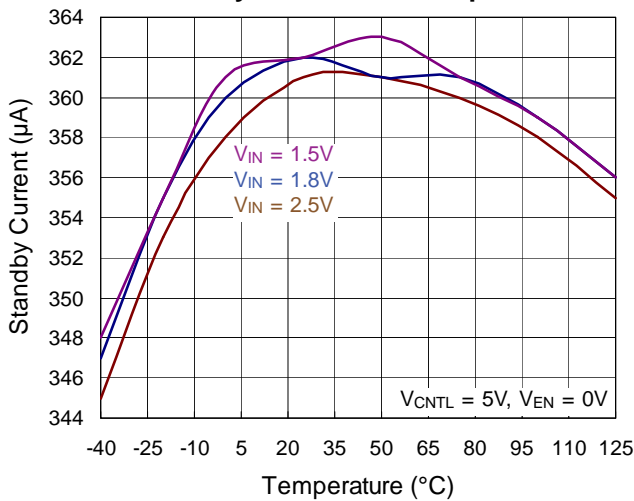

**DDR I Output Voltage vs. Load Current**

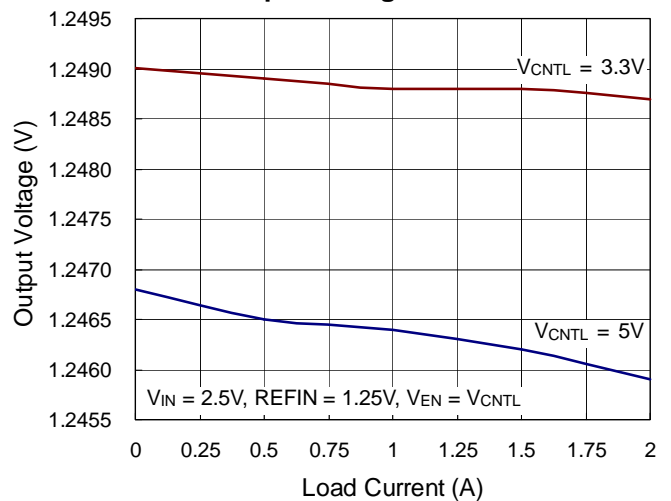

**DDR II Output Voltage vs. Load Current**

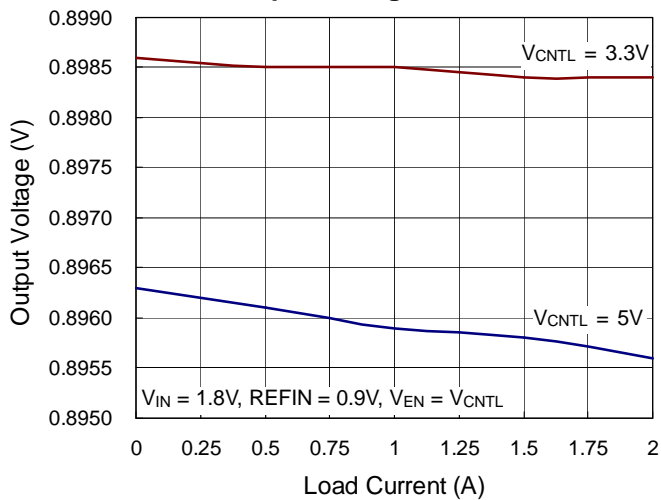

**DDR III Output Voltage vs. Load Current**

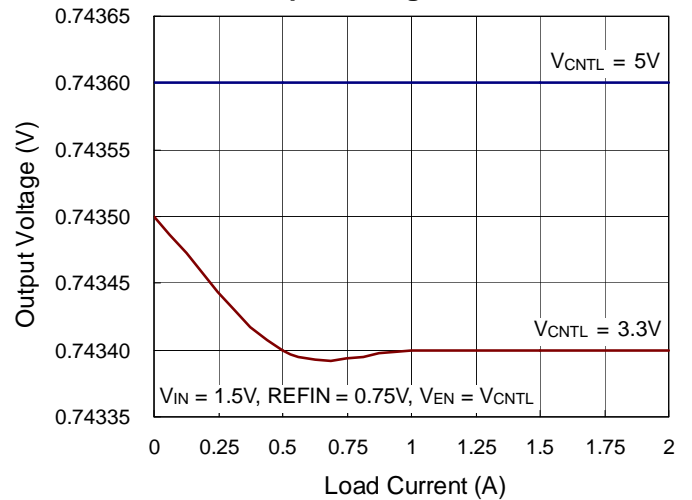

DDR I Output Voltage vs. Load Current

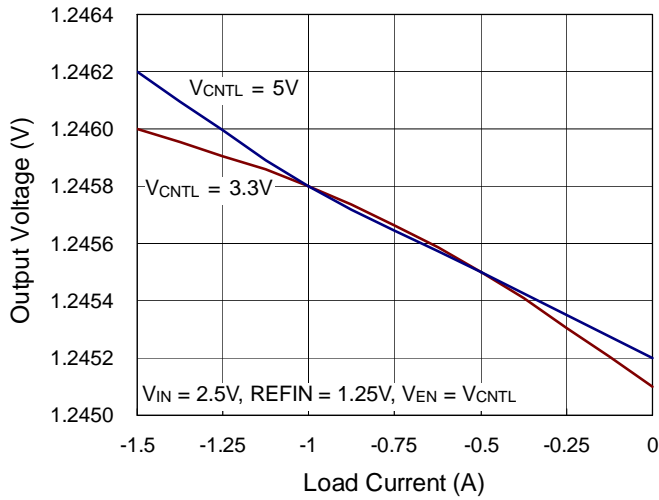

DDR II Output Voltage vs. Load Current

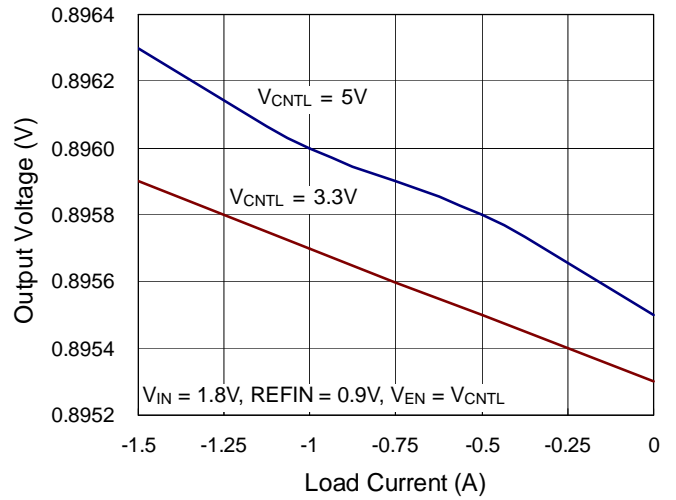

DDR III Output Voltage vs. Load Current

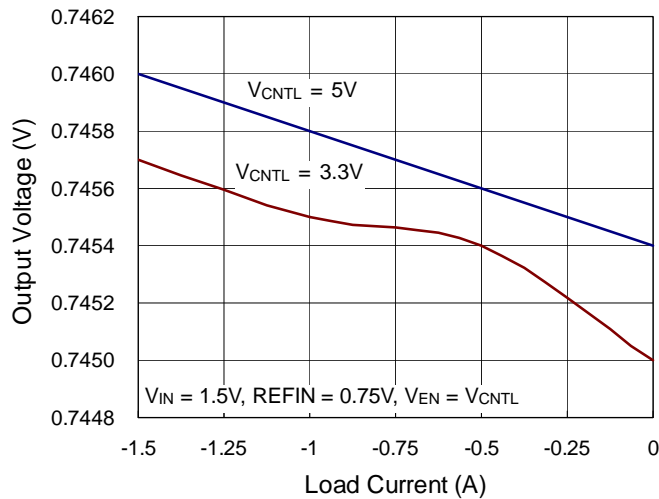

Power On

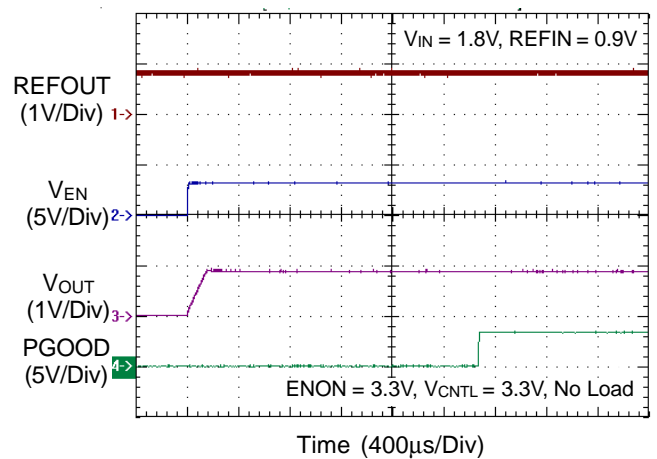

Power Off

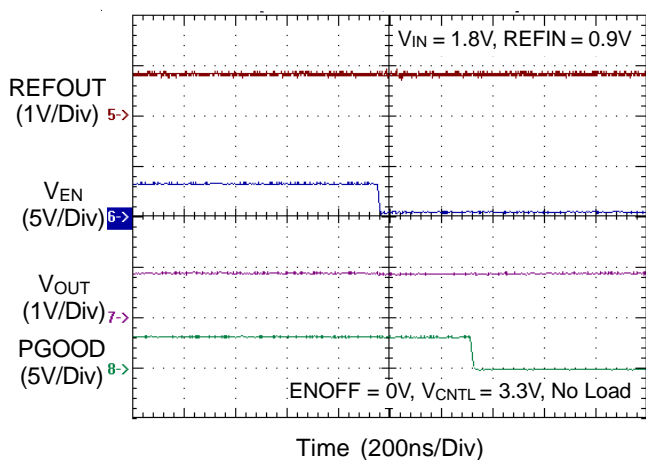

1.25V<sub>OUT</sub> @ ±1.5A Transient Response

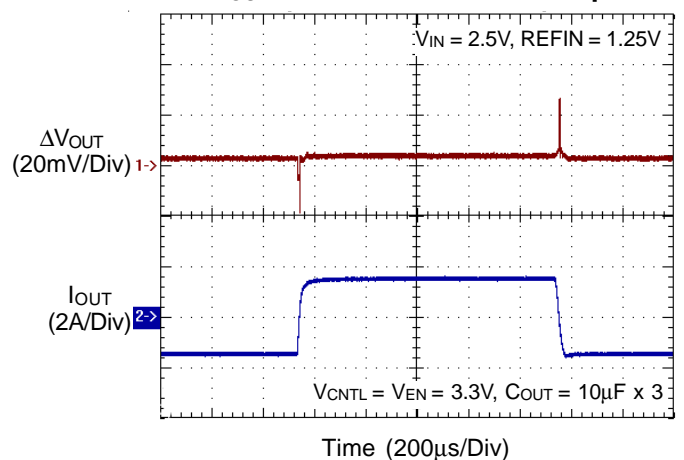

### 0.9V<sub>OUT</sub> @ ±1.5A Transient Response

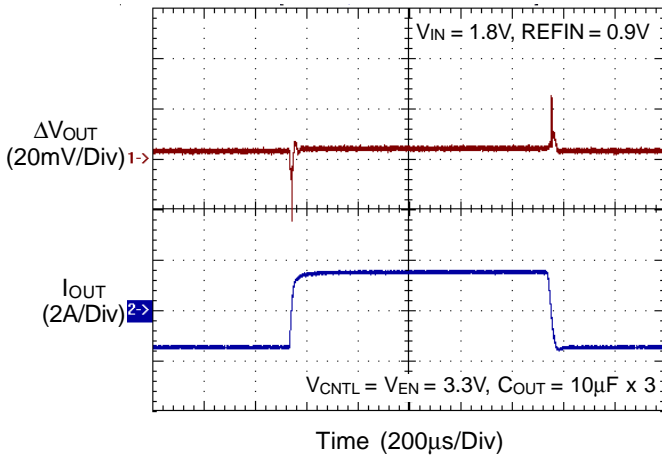

### 0.75V<sub>OUT</sub> @ ±1.5A Transient Response

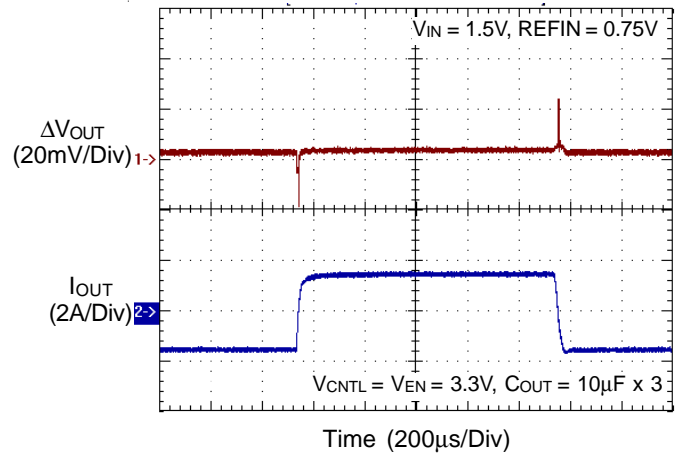

### 1.25V<sub>REFOUT</sub> @ ±15mA Transient Response

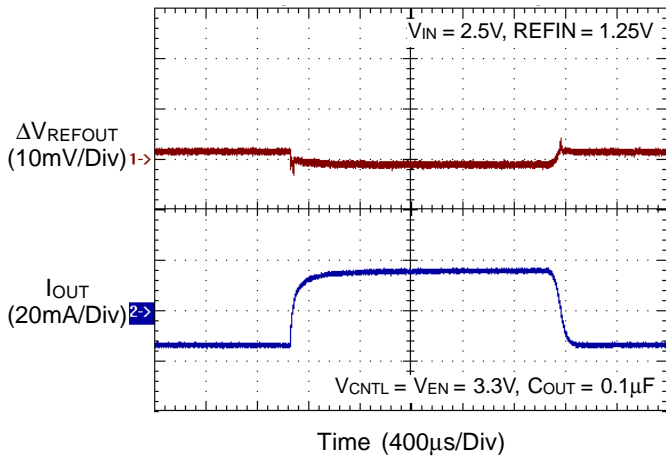



## Application Information

The RT9040 is a sink/source tracking termination regulator.

It is specifically designed for low-cost and low-external component count systems such as notebook PC applications. The RT9040 possesses a high speed operating amplifier that provides fast load transient response and only requires a 10µF ceramic input capacitor and two 10µF ceramic output capacitors.

### REFOUT Regulator

REFOUT is a reference output voltage with source/sink current capability up to 10mA. To ensure stable operation, a 0.1µF ceramic capacitor connected between REFOUT and GND is recommended.

### Capacitor Selection

To achieve best performance of the RT9040, it is recommended to follow the following descriptions for capacitor selection.

VCNTL Capacitor :

Add a ceramic capacitor 4.7µF placed to VCNTL pin as close as possible to stabilize the supply voltage (2.5V, 3.3V or 5.0V rail) from any parasitic impedance from the supply.

VIN Capacitor :

Good bypassing is recommended from VIN to GND to improve transient response. It is recommended to place two 10µF or greater input capacitor located as close as possible to the IC the capacitor must be placed at less than 0.5 inch from the VIN pin.

VOUT Capacitor :

For stable operation, the total capacitance of the VTT output terminal must be greater than 20µF. The RT9040 is designed specifically to work with low ESR ceramic output capacitor in space-saving and performance consideration. Larger output capacitance can reduce the noise and improve load transient response, stability and PSRR. Three 10µF ceramic capacitors are used in the typical application circuit. The output capacitor should be located near the VOUT pin as close as possible.

### Operation State Setting

The EN pin could be connected to SLP\_S3 signal for DDR VTT application. Both VOUT and REFOUT are turned on at normal state( EN = High, REFIN >0.39V). In standby state( EN = Low, REFIN >0.39V), REFOUT voltage will be kept alive to discharge VOUT voltage via internal circuit and left VOUT high impedance. When EN= Low and REFIN <0.39V, the RT9040 enter shutdown state, both VOUT and REFOUT will be turned off and discharged to ground via internal MOSFETs. Table 1 summarizes the above-mentioned operation state setting, and figure 1 shows a typical start up and shutdown timing diagram.

**Table1. Operation State Setting**

STATE	EN	REFIN	VOUT	REFOUT
Normal	High	> 0.39V	ON	ON
Standby	Low	> 0.39V	OFF	ON
Shutdown	Low	< 0.39V	OFF	OFF

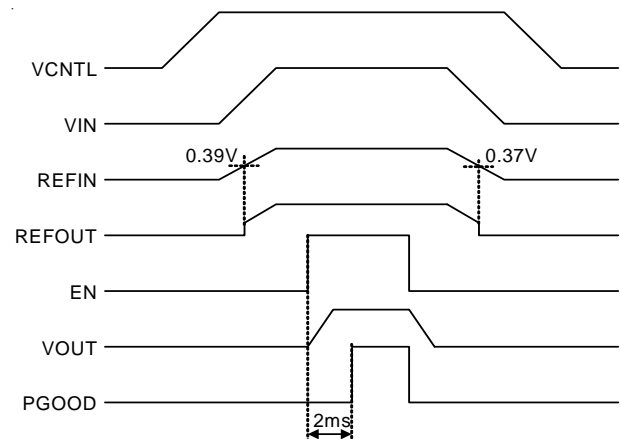

Figure 1. Typical Start Up and Shutdown Timing Diagram

### Thermal Considerations

For continuous operation, do not exceed absolute maximum operation junction temperature. The maximum power dissipation depends on the thermal resistance of IC package, PCB layout, the rate of surroundings airflow and temperature difference between junction to ambient. The maximum power dissipation can be calculated by following formula :

$$P_{D(MAX)} = (T_{J(MAX)} - T_A) / \theta_{JA}$$

Where  $T_{J(MAX)}$  is the maximum operation junction temperature,  $T_A$  is the ambient temperature and the  $\theta_{JA}$  is the junction to ambient thermal resistance.

For recommended operating conditions specification, where  $T_{J(MAX)}$  is 125°C and  $T_A$  is the maximum ambient temperature. The junction to ambient thermal resistance  $\theta_{JA}$  is layout dependent. For WDFN-10L 3x3 packages, the thermal resistance  $\theta_{JA}$  is 70°C/W on the standard JEDEC 51-7 four layers thermal test board. The maximum power dissipation at  $T_A = 25^\circ\text{C}$  can be calculated by following formula :

$$P_{D(MAX)} = (125^\circ\text{C} - 25^\circ\text{C}) / (70^\circ\text{C/W}) = 1.429\text{W for WDFN-10L 3x3 packages}$$

The maximum power dissipation depends on operating ambient temperature for fixed  $T_{J(MAX)}$  and thermal resistance  $\theta_{JA}$ . The Figure 2 of derating curves allows the designer to see the effect of rising ambient temperature on the maximum power allowed.

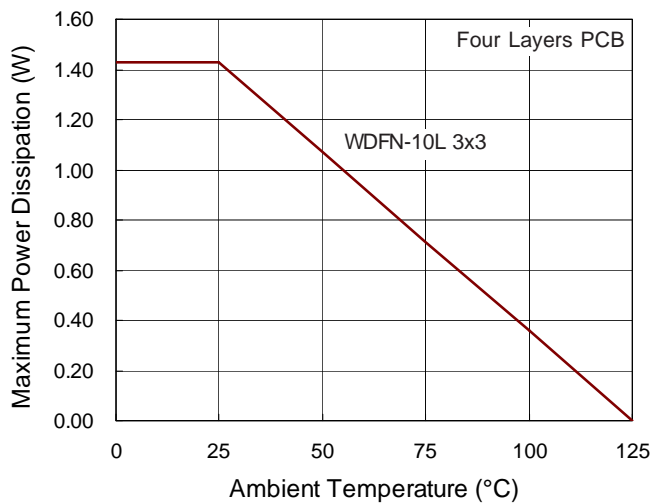
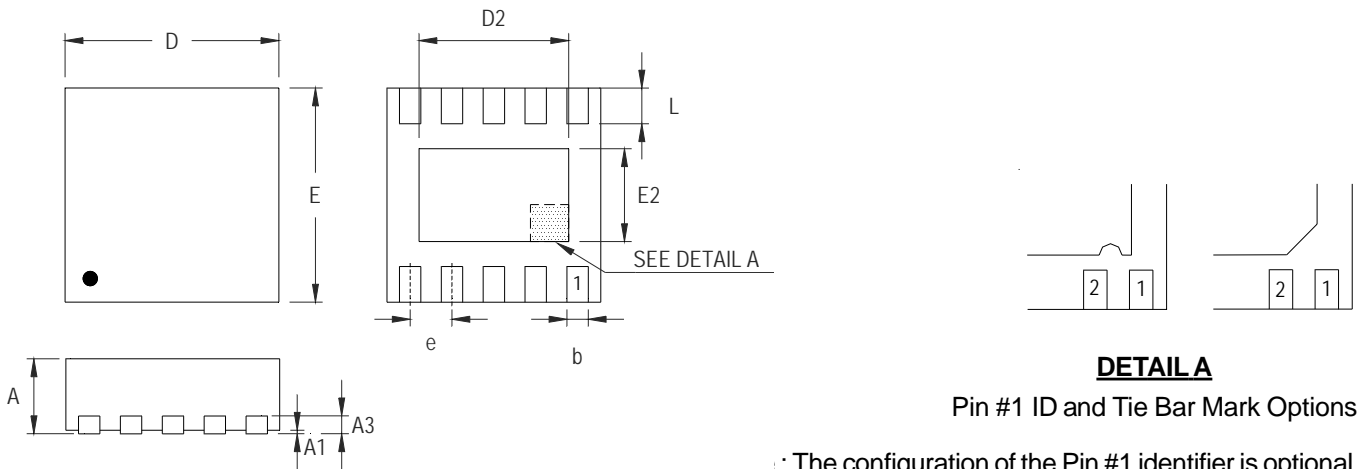

Figure 2. Derating Curve of Maximum Power Dissipation

**Outline Dimension**



**DETAIL A**

Pin #1 ID and Tie Bar Mark Options

: The configuration of the Pin #1 identifier is optional, but must be located within the zone indicated.

Symbol	Dimensions In Millimeters		Dimensions In Inches	
	Min	Max	Min	Max
A	0.700	0.800	0.028	0.031
A1	0.000	0.050	0.000	0.002
A3	0.175	0.250	0.007	0.010
b	0.180	0.300	0.007	0.012
D	2.950	3.050	0.116	0.120
D2	2.300	2.650	0.091	0.104
E	2.950	3.050	0.116	0.120
E2	1.500	1.750	0.059	0.069
e	0.500		0.020	
L	0.350	0.450	0.014	0.018

**W-Type 10L DFN 3x3 Package**

**Richtek Technology Corporation**

14F, No. 8, Tai Yuen 1<sup>st</sup> Street, Chupei City  
 Hsinchu, Taiwan, R.O.C.  
 Tel: (8863)5526789

Richtek products are sold by description only. Richtek reserves the right to change the circuitry and/or specifications without notice at any time. Customers should obtain the latest relevant information and data sheets before placing orders and should verify that such information is current and complete. Richtek cannot assume responsibility for use of any circuitry other than circuitry entirely embodied in a Richtek product. Information furnished by Richtek is believed to be accurate and reliable. However, no responsibility is assumed by Richtek or its subsidiaries for its use; nor for any infringements of patents or other rights of third parties which may result from its use. No license is granted by implication or otherwise under any patent or patent rights of Richtek or its subsidiaries.