

TSL2014

896 × 1 Linear Sensor Array

General Description

The TSL2014 linear sensor array consists of two sections of 448 photodiodes and associated charge amplifier circuitry that can be connected to form a contiguous 896 × 1 array. The pixels measure 120µm (H) by 70µm (W) with 125µm center-to-center spacing and 55µm spacing between pixels. Operation is simplified by internal control logic that requires only a serial-input (SI) signal and a clock.

The TSL2014 is intended for use in a wide variety of applications including mark detection and code reading, optical character recognition (OCR) and contact imaging, edge detection and positioning as well as optical linear and rotary encoding.

Ordering Information and Content Guide appear at end of datasheet.

Key Benefits & Features

The benefits and features of the TSL2014 Linear Sensor Array, are listed below:

Figure 1:
Added Value of Using TSL2014

Benefits	Features
<ul style="list-style-type: none"> Provides High Density Pixel Count 	<ul style="list-style-type: none"> 896 x 1 Sensor-Element Organization
<ul style="list-style-type: none"> Enables High Resolution Scanning 	<ul style="list-style-type: none"> 200 Dots-Per-Inch (DPI) Sensor Pitch
<ul style="list-style-type: none"> Enables Capacitive Threshold Sensing 	<ul style="list-style-type: none"> High Linearity and Uniformity
<ul style="list-style-type: none"> Provides Full Dynamic Range 	<ul style="list-style-type: none"> Rail-to-Rail Output Swing

- Wide Dynamic Range... 2000:1 (66dB)
- Output Referenced to Ground
- Low Image Lag... 0.5% Typ
- Operation to 5MHz
- Single 5V Supply
- 112mm Active Length

Block Diagram

The functional blocks of this device are shown below:

Figure 2:
TSL2014 Block Diagram

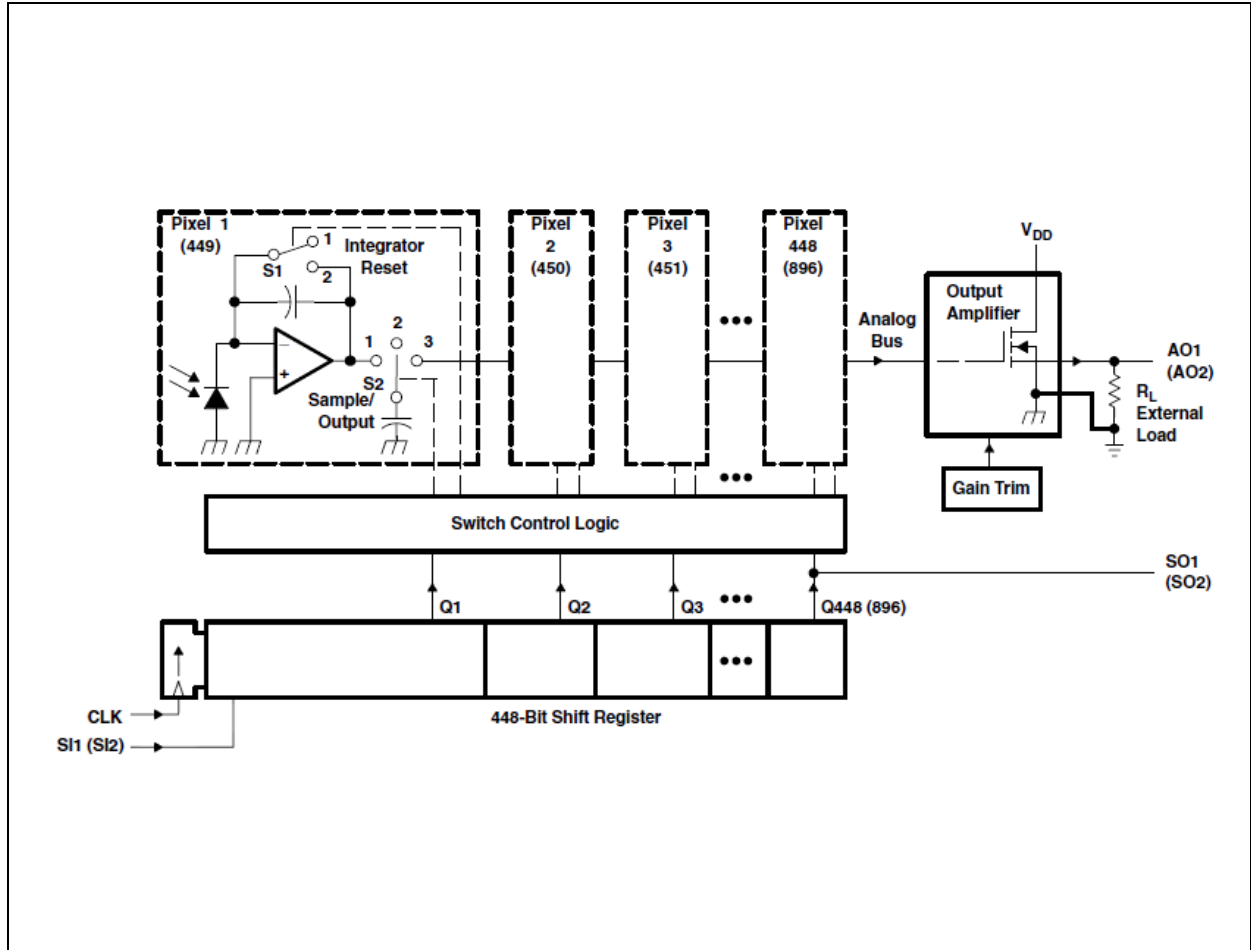

Detailed Description

The sensor consists of 896 photodiodes arranged in a linear array. Light energy impinging on a photodiode generates photocurrent, which is integrated by the active integration circuitry associated with that pixel. During the integration period, a sampling capacitor connects to the output of the integrator through an analog switch. The amount of charge accumulated at each pixel is directly proportional to the light intensity and the integration time. The integration time is the interval between two consecutive output periods.

The output and reset of the integrators is controlled by a 448-bit shift register and reset logic. A 448-pixel output cycle is initiated by clocking in a logic 1 into the SI input of a section for one positive going clock edge (see [Figure 10](#) and [Figure 11](#))¹. The two 448-pixel sections may be operated independently using a single clock input or connected in series to form a 896-pixel array. Each section has an independent output (AO), which may be connected together for the 896-pixel function.

When operating in the 896-pixel mode, as the SI pulse is clocked through the 896-bit shift register, the charge on the sampling capacitor of each pixel is sequentially connected to a charge-coupled output amplifier that generates a voltage output, AO. When the bit position goes low, the pixel integrator is reset. On the 897th clock rising edge, the SI pulse is clocked out of the shift register (S2) and the output assumes a high-impedance state. Note that this 897th clock pulse is required to terminate the output of the 896th pixel and return the internal logic to a known state. A subsequent SI pulse can be presented as early as the 898th clock pulse, thereby initiating another pixel output cycle.

The voltage developed at analog output (AO) is given by:

$$(EQ1) \quad V_{out} = V_{drk} + (R_e) (E_e) (t_{int})$$

where:

- V_{out} is the analog output voltage for white condition
- V_{drk} is the analog output voltage for dark condition
- R_e is the device responsivity for a given wavelength of light given in $V/(\mu J/cm^2)$
- E_e is the incident irradiance in $\mu W/cm^2$
- t_{int} is integration time in seconds

1. For proper operation, after meeting the minimum hold time condition, SI must go low before the next rising edge of the clock.

AO is driven by a source follower that requires an external pulldown resistor (330Ω typical). The output is nominally 0V for no light input, 2V for normal white-level, and 3.4V for saturation light level. When the device is not in the output phase, AO is in a high impedance state.

A 0.1 μF bypass capacitor should be connected between V_{DD} and ground as close as possible to the device.

Pin Assignments

The TSL2014 pin assignments are described below:

Figure 3:
Pin Diagram of Package (Top View)

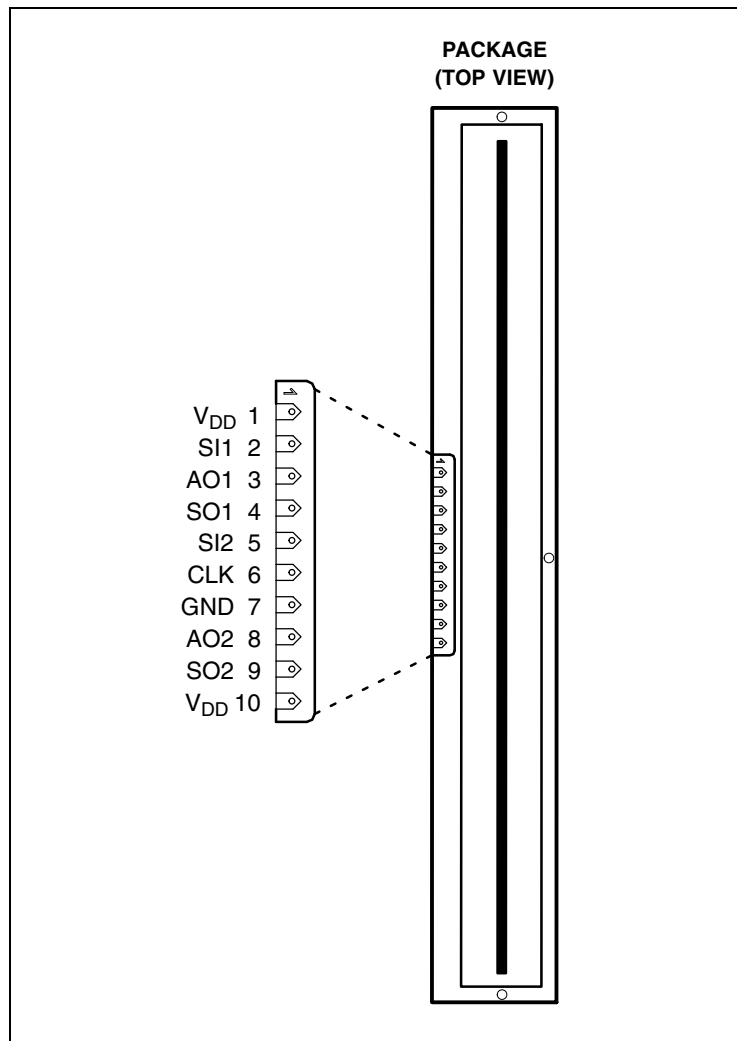

Figure 4:
Terminal Functions

Terminal		I/O	Description
Name	No.		
V _{DD}	1, 10		Supply voltage. Supply voltage for both analog and digital circuits.
SI1	2	I	Serial input (section 1). SI1 defines the start of the data-out sequence.
AO1	3	O	Analog output of section 1.
SO1	4	O	Serial output (section 1). SO1 signals the end of the data out sequence and provides a signal to drive the input of section 2 (SI2) in serial mode.
SI2	5	I	Serial input (section 2). SI2 defines the start of the data-out sequence.
CLK	6	I	Clock. The clock controls the charge transfer, pixel output and reset.
GND	7		Ground (substrate). All voltages are referenced to GND.
AO2	8	O	Analog output of section 2.
SO2	9	O	Serial output (section 2). SO2 signals the end of the data out sequence and provides a signal to drive the input of another device for cascading.

Absolute Maximum Ratings

Stresses beyond those listed under [Absolute Maximum Ratings](#) may cause permanent damage to the device. These are stress ratings only. Functional operation of the device at these or any other conditions beyond those indicated under [Electrical Characteristics](#) is not implied. Exposure to absolute maximum rating conditions for extended periods may affect device reliability.

Figure 5:
Absolute Maximum Ratings

Symbol	Parameter	Min	Max	Unit
V_{DD}	Supply voltage range	-0.3	6	V
V_I	Input voltage range	-0.3	$V_{DD} + 0.3V$	V
I_{IK}	Input clamp current, ($V_I < 0$) or ($V_I > V_{DD}$)	-20	20	mA
I_{OK}	Output clamp current, ($V_O < 0$) or ($V_O > V_{DD}$)	-25	25	mA
V_O	Voltage range applied to any output in the high impedance or power-off state	-0.3	$V_{DD} + 0.3V$	V
I_O	Continuous output current, ($V_O = 0$ to V_{DD})	-25	25	mA
	Continuous current through V_{DD} or GND	-150	150	mA
I_O	Analog output current range	-25	25	mA
T_A	Operating free-air temperature range	-25	85	°C
T_{strg}	Storage temperature range	-25	85	°C
	Lead temperature on solder pads for 10 seconds		260	°C
ESD_{HBM}	ESD tolerance, human body model	±2000		V

Electrical Characteristics

All limits are guaranteed. The parameters with min and max values are guaranteed with production tests or SQC (Statistical Quality Control) methods.

Figure 6:
Recommended Operating Conditions (see Figure 10 and Figure 11)

Symbol	Parameter	Min	Nom	Max	Unit
V_{DD}	Supply voltage	4.5	5	5.5	V
V_I	Input voltage	0		V_{DD}	V
V_{IH}	High-level input voltage	2		V_{DD}	V
V_{IL}	Low-level input voltage	0		0.8	V
λ	Wavelength of light source	400		1000	nm
f_{clock}	Clock frequency	5		5000	kHz
t_{int}	Sensor integration time, serial	0.1792		100	ms
t_{int}	Sensor integration time, parallel	0.090		100	ms
T_A	Operating free-air temperature	0		70	°C
R_L	Load resistance	300		4700	Ω
C_L	Load capacitance			330	pF

Figure 7:
Electrical Characteristics at $f_{clock} = 200\text{kHz}$, $V_{DD} = 5\text{V}$, $T_A = 25^\circ\text{C}$, $\lambda_p = 640\text{nm}$, $t_{int} = 5\text{ms}$, $R_L = 330\Omega$, $E_e = 18\mu\text{W}/\text{cm}^2$ (unless otherwise noted)

Symbol	Parameter	Test Conditions	Min	Typ	Max	Unit
V_{out}	Analog output voltage (white, average over 896 pixels)	See note (1)	1.6	2	2.4	V
V_{drk}	Analog output voltage (dark, average over 896 pixels)		0	0.05	0.15	V
PRNU	Pixel response non-uniformity	See note (2) and See note (3)		7%	20%	
	Nonlinearity of analog output voltage	See note (3)		$\pm 0.4\%$		FS
	Output noise voltage	See note (4)		1		mVrms
R_e	Responsivity		16	22	28	V/ ($\mu\text{W}/\text{cm}^2$)

Symbol	Parameter	Test Conditions	Min	Typ	Max	Unit
SE	Saturation exposure	See note (5)		155		nJ/cm ²
V _{sat}	Analog output saturation voltage		2.5	3.4		V
DSNU	Dark signal non-uniformity	All pixels See note (6)		25	120	mV
IL	Image lag	See note (7)		0.5%		
I _{DD}	Supply current, output idle			53	80	mA
I _{IH}	High-level input current	V _I = V _{DD}			10	μA
I _{IL}	Low-level input current	V _I = 0			10	μA
V _{OH}	High level output voltage SO1 and SO2	I _O = 50μA	4.5	4.95		V
		I _O = 4mA		4.6		
V _{OL}	Low level output voltage SO1 and SO2	I _O = 50μA		0.01	0.1	V
		I _O = 4mA		0.4		
C _{i(SI)}	Input capacitance, SI			35		pF
C _{i(CLK)}	Input capacitance, CLK			70		pF

Note(s):

1. The array is uniformly illuminated with a diffused LED source having a peak wavelength of 640nm.
2. PRNU is the maximum difference between the voltage from any single pixel and the average output voltage from all pixels of the device under test when the array is uniformly illuminated at the white irradiance level. PRNU includes DSNU.
3. Nonlinearity is defined as the maximum deviation from a best-fit straight line over the dark-to-white irradiance levels, as a percent of analog output voltage (white).
4. RMS noise is the standard deviation of a single-pixel output under constant illumination as observed over a 5-second period.
5. Minimum saturation exposure is calculated using the minimum V_{sat}, the maximum V_{drk}, and the maximum Re.
6. DSNU is the difference between the maximum and minimum output voltage for all pixels in the absence of illumination.
7. Image lag is a residual signal left in a pixel from a previous exposure. It is defined as a percent of white-level signal remaining after a pixel is exposed to a white condition followed by a dark condition:

$$IL = \frac{V_{out(IL)} - V_{drk}}{V_{out(white)} - V_{drk}} \times 100$$

Figure 8:
Timing Requirements (see Figure 10 and Figure 11)

Symbol	Parameter	Min	Nom	Max	Unit
$t_{su(SI)}$	Setup time, serial input ⁽¹⁾	20			ns
$t_{h(SI)}$	Hold time, serial input ^{(1), (2)}	0			ns
t_w	Pulse duration, clock high or low	50			ns
t_r, t_f	Input transition (rise and fall) time	0		500	ns

Note(s):

1. Input pulses have the following characteristics: $t_r = 6\text{ns}$, $t_f = 6\text{ns}$.
2. SI must go low before the rising edge of the next clock pulse.

Figure 9:
Dynamic Characteristics over Recommended Ranges of Supply Voltage and Operating Free-Air Temperature (see Figure 11)

Symbol	Parameter	Test Conditions	Min	Typ	Max	Unit
t_s	Analog output settling time to $\pm 1\%$	$R_L = 330\Omega$, $C_L = 10\text{pF}$		185		ns
t_{pd}	Propagation delay time, SO1 and SO2			50		ns

Typical Characteristics

Figure 10:
Timing Waveforms (Each Section)

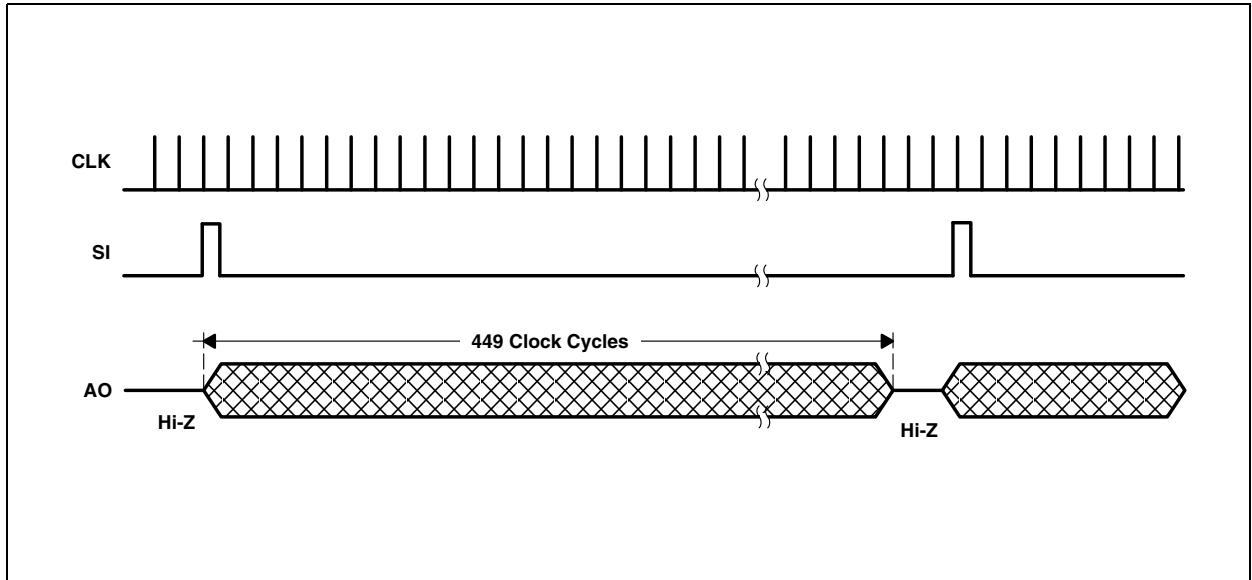

Figure 11:
Operational Waveforms (Each Section)

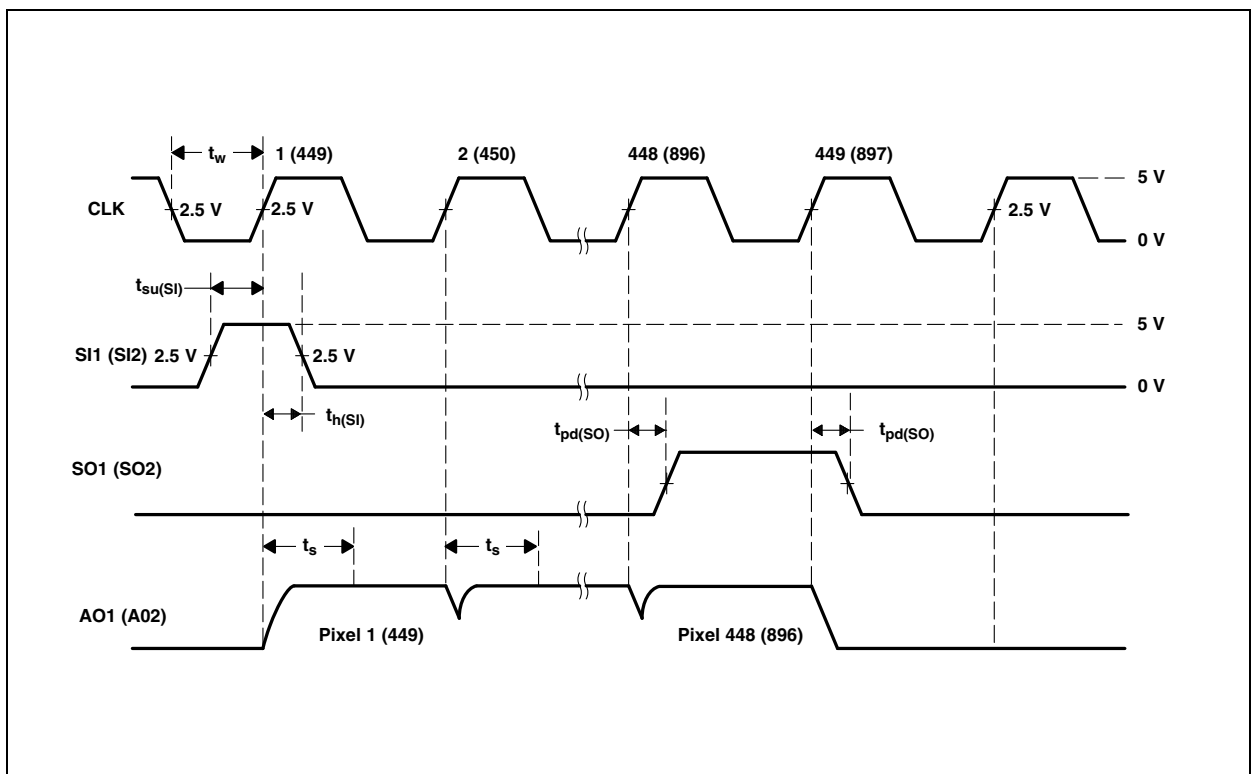

Figure 12:
Photodiode Spectral Responsivity

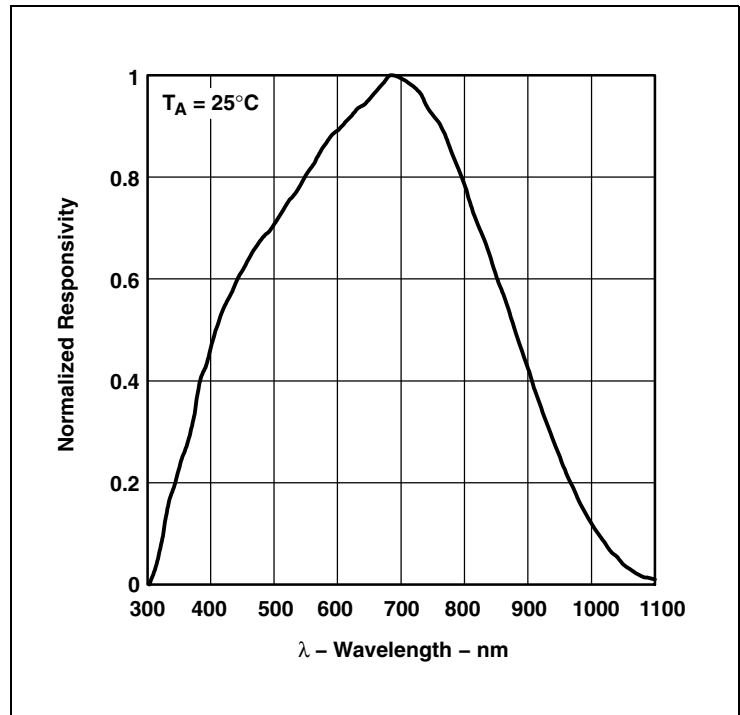
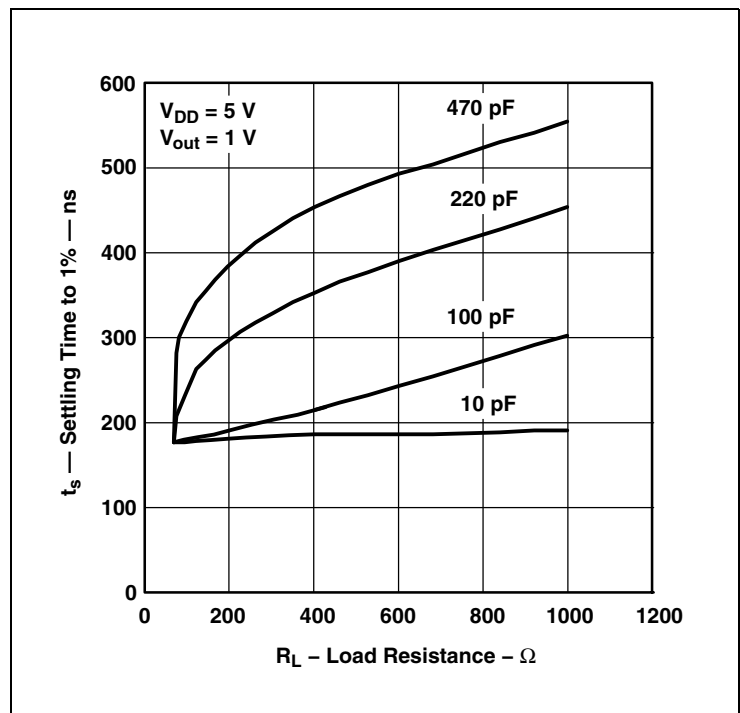

Figure 13:
Analog Output Settling Time vs. Load Capacitance and Resistance



Application Information

Integration Time

The integration time of the linear array is the period during which light is sampled and charge accumulates on each pixel's integrating capacitor. The flexibility to adjust the integration period is a powerful and useful feature of the ams AG TSL2xx linear array family. By changing the integration time, a desired output voltage can be obtained on the output pin while avoiding saturation for a wide range of light levels.

Each pixel of the linear array consists of a light-sensitive photodiode. The photodiode converts light intensity to a voltage. The voltage is sampled on the Sampling Capacitor by closing switch S2 (position 1) (see [Figure 2](#) on page 2). Logic controls the resetting of the Integrating Capacitor to zero by closing switch S1 (position 2).

At SI input (Start Integration), pixel 1 is accessed. During this event, S2 moves from position 1 (sampling) to position 3 (holding). This holds the sampled voltage for pixel 1. Switch S1 for pixel 1 is then moved to position 2. This resets (clears) the voltage previously integrated for that pixel so that pixel 1 is now ready to start a new integration cycle. When the next clock period starts, the S1 switch is returned to position 1 to be ready to start integrating again. S2 is returned to position 1 to start sampling the next light integration. Then the next pixel starts the same procedure. The integration time is the time from a specific pixel read to the next time that pixel is read again. If either the clock speed or the time between successive SI pulses is changed, the integration time will vary. After the final (n^{th}) pixel in the array is read on the output, the output goes into a high-impedance mode. A new SI pulse can occur on the ($n+1$) clock causing a new cycle of integration/output to begin. Note that the time between successive SI pulses must not exceed the maximum integration time of 100msec.

The minimum integration time for any given array is determined by time required to clock out all the pixels in the array and the time to discharge the pixels. The time required to discharge the pixels is a constant. Therefore, the minimum integration period is simply a function of the clock frequency and the number of pixels in the array. A slower clock speed increases the minimum integration time and reduces the maximum light level for saturation on the output. The minimum integration time shown in this data sheet is based on the maximum clock frequency of 5 MHz.

The minimum integration time can be calculated from the equation:

$$(EQ2) \quad T_{\text{int}(\text{min})} = \left(\frac{1}{\text{maximum clock frequency}} \right) \times n$$

where:

n is the number of pixels

In the case of the TSL2014, the minimum integration time would be:

$$T_{\text{int}(\text{min})} = 200\text{ns} \times 896 = 179.2\mu\text{s}$$

It is important to note that not all pixels will have the same integration time if the clock frequency is varied while data is being output.

It is good practice on initial power up to run the clock ($n+1$) times after the first SI pulse to clock out indeterminate data from power up. After that, the SI pulse is valid from the time following ($n+1$) clocks. The output will go into a high-impedance state after the $n+1$ high clock edge. It is good practice to leave the clock in a low state when inactive because the SI pulse required to start a new cycle is a low-to-high transition.

The integration time chosen is valid as long as it falls in the range between the minimum and maximum limits for integration time. If the amount of light incident on the array during a given integration period produces a saturated output (Max Voltage output), then the data is not accurate. If this occurs, the integration period should be reduced until the analog output voltage for each pixel falls below the saturation level. The goal of reducing the period of time the light sampling window is active is to lower the output voltage level to prevent saturation. However, the integration time must still be greater than or equal to the minimum integration period.

If the light intensity produces an output below desired signal levels, the output voltage level can be increased by increasing the integration period provided that the maximum integration time is not exceeded. The maximum integration time is limited by the length of time the integrating capacitors on the pixels can hold their accumulated charge. The maximum integration time should not exceed 100ms for accurate measurements.

Although the linear array is capable of running over a wide range of operating frequencies up to a maximum of 5MHz, the speed of the A/D converter used in the application is likely to be the limiter for the maximum clock frequency. The voltage output is available for the whole period of the clock, so the setup and hold times required for the analog-to-digital conversion must be less than the clock period.

Connection Diagrams

Figure 14:
Connection Diagrams

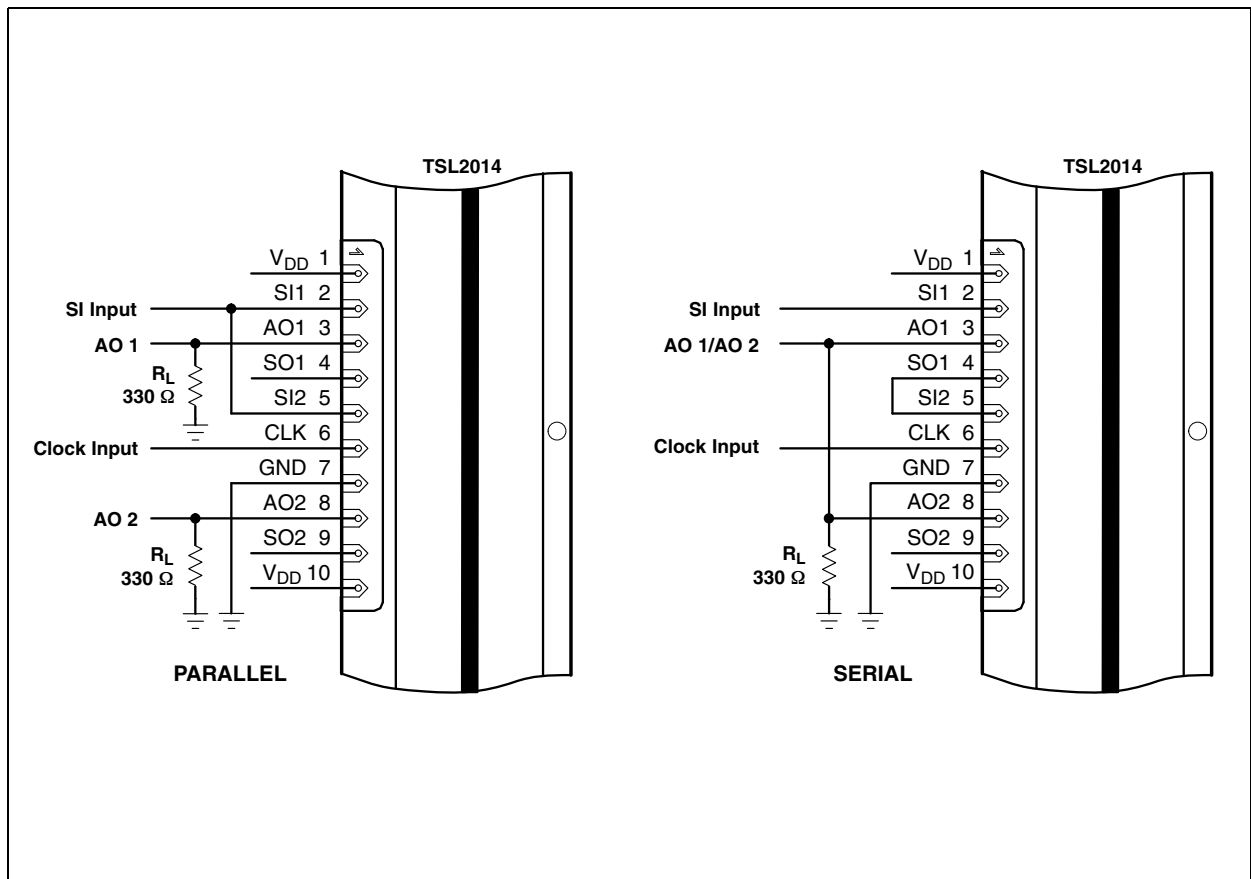

Mechanical Information

Figure 15:
TSL2014 Mechanical Specifications

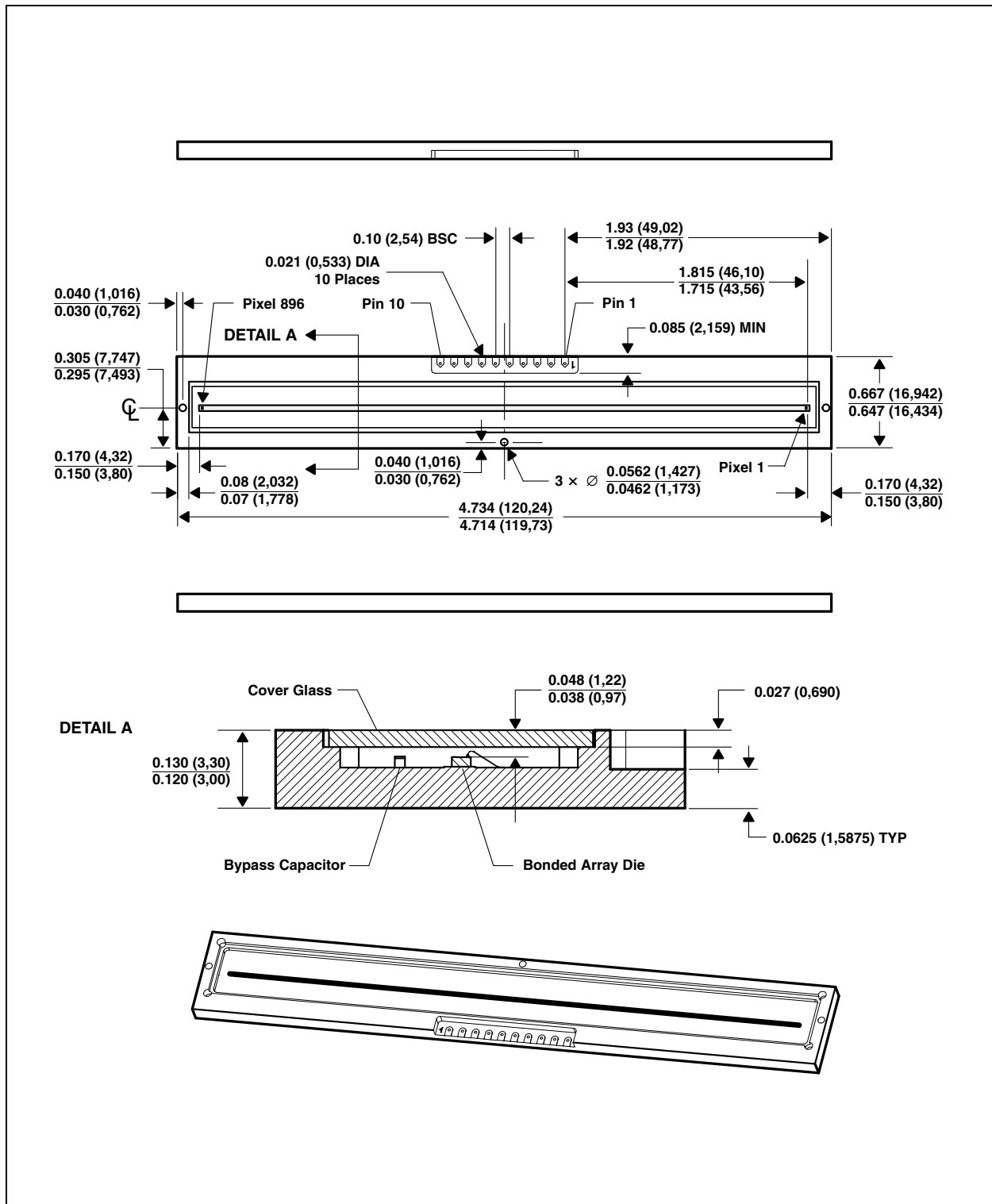

Note(s):

1. All linear dimensions are in inches (millimeters).
2. Cover glass index of refraction is 1.52.
3. Pixel centers are located along the centerline of the mounting holes.
4. This drawing is subject to change without notice.

Ordering & Contact Information

Figure 16:
Ordering Information

Ordering Code	Type	Delivery Form	Delivery Quantity
TSL2014	896 x 1 Array	Box	30 pcs/box

Buy our products or get free samples online at:

www.ams.com/ICdirect

Technical Support is available at:

www.ams.com/Technical-Support

Provide feedback about this document at:

www.ams.com/Document-Feedback

For further information and requests, e-mail us at:

ams_sales@ams.com

For sales offices, distributors and representatives, please visit:

www.ams.com/contact

Headquarters

ams AG

Tobelbaderstrasse 30

8141 Premstaetten

Austria, Europe

Tel: +43 (0) 3136 500 0

Website: www.ams.com

RoHS Compliant & ams Green Statement

RoHS: The term RoHS compliant means that ams AG products fully comply with current RoHS directives. Our semiconductor products do not contain any chemicals for all 6 substance categories, including the requirement that lead not exceed 0.1% by weight in homogeneous materials. Where designed to be soldered at high temperatures, RoHS compliant products are suitable for use in specified lead-free processes.

ams Green (RoHS compliant and no Sb/Br): ams Green defines that in addition to RoHS compliance, our products are free of Bromine (Br) and Antimony (Sb) based flame retardants (Br or Sb do not exceed 0.1% by weight in homogeneous material).

Important Information: The information provided in this statement represents ams AG knowledge and belief as of the date that it is provided. ams AG bases its knowledge and belief on information provided by third parties, and makes no representation or warranty as to the accuracy of such information. Efforts are underway to better integrate information from third parties. ams AG has taken and continues to take reasonable steps to provide representative and accurate information but may not have conducted destructive testing or chemical analysis on incoming materials and chemicals. ams AG and ams AG suppliers consider certain information to be proprietary, and thus CAS numbers and other limited information may not be available for release.

Copyrights & Disclaimer

Copyright ams AG, Tobelbader Strasse 30, 8141 Premstaetten, Austria-Europe. Trademarks Registered. All rights reserved. The material herein may not be reproduced, adapted, merged, translated, stored, or used without the prior written consent of the copyright owner.

Devices sold by ams AG are covered by the warranty and patent indemnification provisions appearing in its General Terms of Trade. ams AG makes no warranty, express, statutory, implied, or by description regarding the information set forth herein. ams AG reserves the right to change specifications and prices at any time and without notice. Therefore, prior to designing this product into a system, it is necessary to check with ams AG for current information. This product is intended for use in commercial applications. Applications requiring extended temperature range, unusual environmental requirements, or high reliability applications, such as military, medical life-support or life-sustaining equipment are specifically not recommended without additional processing by ams AG for each application. This product is provided by ams AG "AS IS" and any express or implied warranties, including, but not limited to the implied warranties of merchantability and fitness for a particular purpose are disclaimed.

ams AG shall not be liable to recipient or any third party for any damages, including but not limited to personal injury, property damage, loss of profits, loss of use, interruption of business or indirect, special, incidental or consequential damages, of any kind, in connection with or arising out of the furnishing, performance or use of the technical data herein. No obligation or liability to recipient or any third party shall arise or flow out of ams AG rendering of technical or other services.

Document Status

Document Status	Product Status	Definition
Product Preview	Pre-Development	Information in this datasheet is based on product ideas in the planning phase of development. All specifications are design goals without any warranty and are subject to change without notice
Preliminary Datasheet	Pre-Production	Information in this datasheet is based on products in the design, validation or qualification phase of development. The performance and parameters shown in this document are preliminary without any warranty and are subject to change without notice
Datasheet	Production	Information in this datasheet is based on products in ramp-up to full production or full production which conform to specifications in accordance with the terms of ams AG standard warranty as given in the General Terms of Trade
Datasheet (discontinued)	Discontinued	Information in this datasheet is based on products which conform to specifications in accordance with the terms of ams AG standard warranty as given in the General Terms of Trade, but these products have been superseded and should not be used for new designs

Revision Information

Changes from 040C (2011-Aug) to current revision 1-00 (2016-Mar-31)	Page
Content of TAOS datasheet was converted to latest ams design	
Added Ordering Information	16

Note(s):

1. Page and figure numbers for the previous version may differ from page and figure numbers in the current revision.
2. Correction of typographical errors is not explicitly mentioned.

Content Guide

1	General Description
1	Key Benefits & Features
2	Block Diagram
3	Detailed Description
4	Pin Assignments
6	Absolute Maximum Ratings
7	Electrical Characteristics
10	Typical Characteristics
12	Application Information
12	Integration Time
14	Connection Diagrams
15	Mechanical Information
16	Ordering & Contact Information
17	RoHS Compliant & ams Green Statement
18	Copyrights & Disclaimer
19	Document Status
20	Revision Information