

Introduction

The ISL6526 and the ISL6527 provide power control and protection for applications requiring low voltage and high power. Both ICs can be biased from voltages between 3.3V and 5V. The ISL6526 and ISL6527 contain a high performance error amplifier, a high accuracy reference, a fixed 300kHz or 600kHz internal oscillator, over-current protection circuitry, and two MOSFET drivers for use in synchronous-rectified buck converters. Both the ISL6526 and the ISL6527 are capable of regulating the output voltage while the DC-DC converter is sinking current. The ISL6527 also allows for an external reference to be used. All these features are packaged in a small 14-lead SOIC or a 16-lead 5x5[mm] MLFP. More complete descriptions of the ISL6526 and the ISL6527 can be found in their respective datasheets [1, 2].

This application note details the ISL6526 and ISL6527 in DC-DC converters for applications requiring a tightly regulated, fixed output voltage. Low-cost applications requiring a DC-DC converter can benefit from one of the designs presented in this application note

ISL6526/27 Reference Designs

The ISL6526/27 evaluation board highlights the operation of the ISL6526 and ISL6527 ICs in an embedded application. There are five evaluation boards from which to choose.

Table 1 - Evaluation Boards

| Board Name | Switching Frequency | IC | Package |
|--------------|---------------------|-------------------------|------------|
| ISL6526EVAL1 | 300kHz and 600kHz | ISL6526CB ISL6526ACB | 14 ld SOIC |
| ISL6526EVAL2 | 300kHz | ISL6526CR | 16 ld MLFP |
| ISL6527EVAL1 | 300kHz and 600kHz | ISL6527CB ISL6527ACB | 14 ld SOIC |
| ISL6527EVAL2 | 600kHz | ISL6527ACR | 16 ld MLFP |

The ISL6526EVAL1 board is built with the ISL6526CB and shipped with an ISL6526ACB sample piece. Evaluation of the ISL6526CB can be performed immediately. If evaluation of the ISL6526ACB is desired, then it is a simple matter of replacing the controller. The ISL6527EVAL1 is shipped with the ISL6527CB and shipped with an ISL6527ACB sample piece. As with the ISL6526CB and ISL6526ACB, the parts are interchangeable.

The ISL6526EVAL2 and ISL6527EVAL2 are ready for evaluation without any modifications.

All evaluation boards have the same output filter, compensation components and MOSFETs. They are configured for an output of 2.5V with a maximum load of 5A. The ISL6526 evaluation boards have a fixed output while the ISL6527 evaluation boards allow the use of a potentiometer to adjust the output voltage from 0.75V to 3.0V. Unless otherwise noted, this application note assumes that the output of the ISL6527 evaluation board is 2.5V.

Quick Start Evaluation

The evaluation board is shipped 'ready to use' right from the box. The board accepts a range of input voltages from 3.3V to 5V from a standard power supply. The output can be exercised through an external load.

There are posts available on the board for introducing power to the board and also for drawing current from the regulated output. Three probe points are also available for use. These probe points provide Kelvin connections to the CPVOUT(TP3) and CT1(TP1) pins on both the ISL6526 and ISL6527. The ENABLE pin on the ISL6526 and the REF_IN pin on the ISL6527 can be probed from TP2.

Recommended Test Equipment

To test the functionality of the ISL6526 or ISL6527, the following equipment is recommended:

- An adjustable 0 - 5V, 5A capable bench power supply
- An electronic load
- Four channel oscilloscope with probes
- Precision digital multimeter

Power and Load Connections

There are 2 sets of terminals that are used to supply the input voltage and load the output.

INPUT VOLTAGE

Connect the positive lead of the adjustable bench power supply to the 3.3V post (J1). Connect the ground lead of the supply to GND post (J2).

OUTPUT LOADING - SOURCING CURRENT

Connect the positive terminal of the load to the VOUT post (J3). Connect the return terminal of the same load to the GND post (J4).

OUTPUT LOADING - SINKING CURRENT

CAUTION: The return terminal of the load must float for this to work properly.

To observe the output while the regulator sinks current, connect the positive terminal of the load to the 3.3V post (J1). Connect the return terminal of the same load to the V_{OUT} post (J3).

Startup

There are two distinct start up methods for both the ISL6526 and ISL6527 regulators. The first method is invoked through the application of power to the IC. The soft-start feature allows for a controlled rise of the output once the Power On Reset (POR) threshold of the input voltage has been reached. Figure 1 shows the start up profile of the regulator in relation to the start up of the 3.3V input supply and the bias supply generated by the charge pump. Both the ISL6526 and ISL6527, whether switching at 300 or 600kHz, will have the same start up profile as shown in Figure 1.

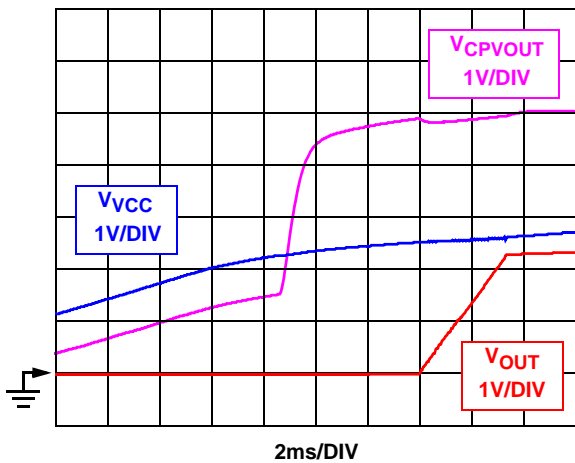

FIGURE 1. START UP FROM POR

The second method of start up is through the use of the Enable/Shutdown feature. Holding the ENABLE pin on the ISL6526 or the OCSET/SD pin on the ISL6527 below 0.8V will disable the regulator by forcing both the upper and lower MOSFETs off. Releasing the respective pin allows the regulator to start up. Figure 2 shows the start up profile with this method.

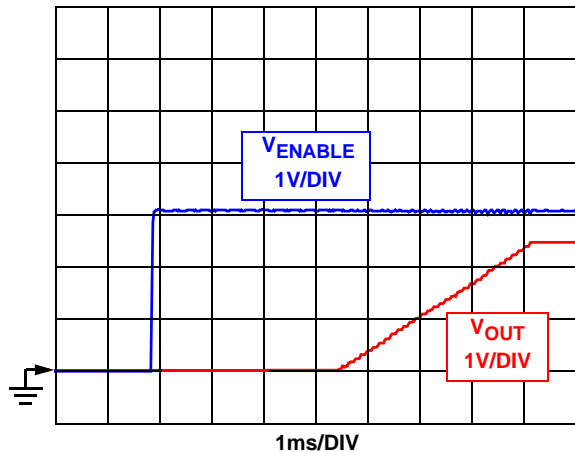

FIGURE 2. START UP FROM SHUT DOWN

Shutdown

As discussed in the previous section, if the OCSET/SD pin or ENABLE pin is pulled down and held below 0.8V, the regulator will be turned off. The MOSFET gates are immediately pulled low. Figure 3 shows the shutdown profile of the regulator under full load.

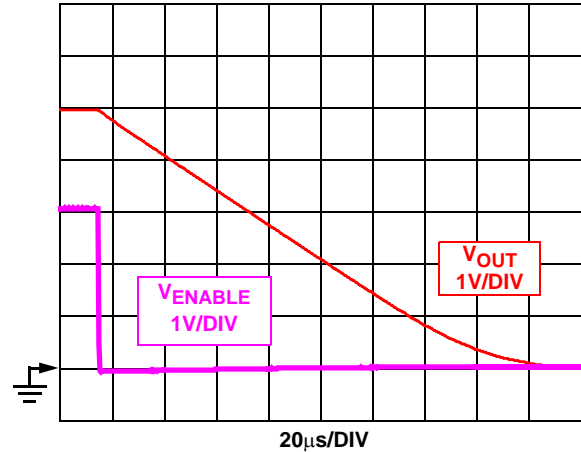

FIGURE 3. SHUTDOWN WITH FULL LOAD (ISL6526)

ISL6527 Input Reference

A distinguishing feature of the ISL6527 is that the reference used to regulate the output is provided from an external source. This allows the converter to track the output of another regulator at any desired ratio or amplify a small signal. Figure 4 illustrates the tracking and power amplification ability of the ISL6527 with a sinusoidal reference. Figure 4 also illustrates the startup profile.

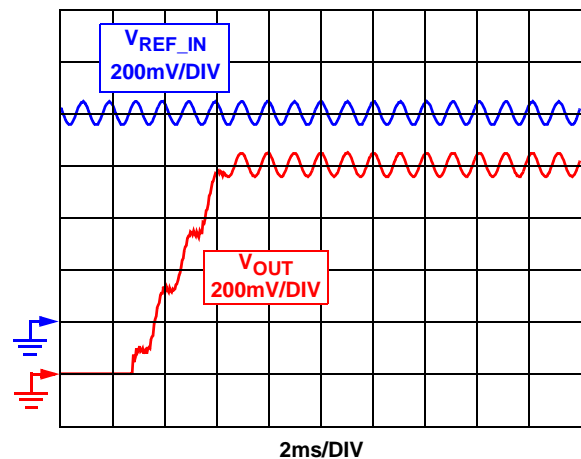

FIGURE 4. SMALL SIGNAL POWER AMPLIFICATION

Ripple Voltage

Figure 5 shows the ripple voltage on the output of the regulator. The ripple voltages shown are for both the ISL6526 and ISL6527 ICs running at either 300 or 600kHz.

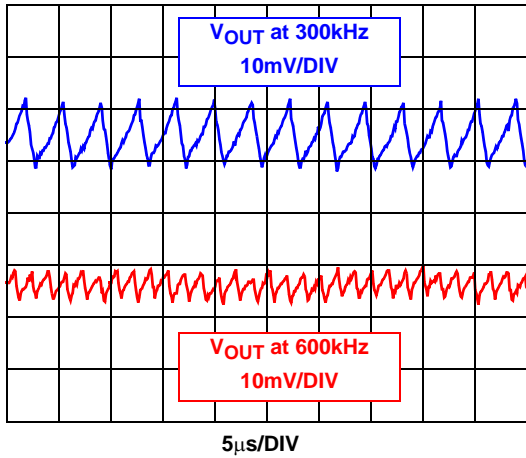

FIGURE 5. OUTPUT RIPPLE VOLTAGE

Transient Performance

Figures 6 and 7 show the response of the output when subjected to sourcing and sinking transient loading, respectively.

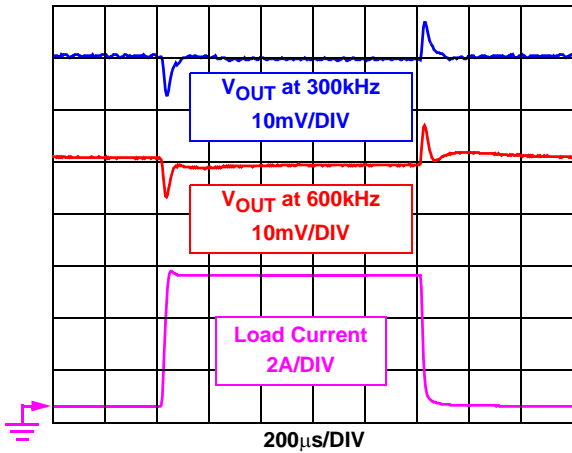

FIGURE 6. SOURCING TRANSIENT

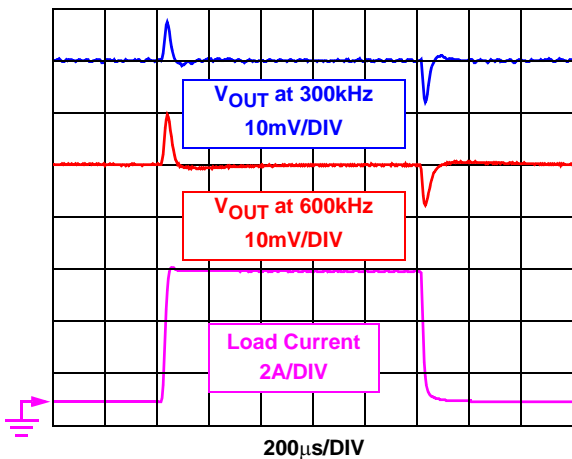

FIGURE 7. SINKING TRANSIENT

Lossless Output Voltage Droop

Droop is an intentional sag in the output voltage that is proportional to the output current. Although not necessary for proper circuit operation, utilizing droop allows the dynamic regulation to be improved by taking advantage of static regulation requirements and expanding the available headroom for transient edge output excursions. In practical applications that are compared to a non-droop implementation, the droop implementation requires fewer output capacitors or better regulation with the same type and number of output capacitors.

By moving the regulation point ahead of the output inductor (at the PHASE node), droop becomes equal to the average voltage drop across the output inductor's DC resistance as well as any distributed resistance. The droop circuitry is simply an RC low pass filter placed across the output inductor. This filter must have the same time constant that the output inductor and its corresponding DCR have. The design must be careful to include any parasitic impedances of the PC board if the DCR of the inductor is very low.

The ISL6526/27 evaluation board does not have any component footprints that would allow an implementation of droop. This section is included in this application note as a guideline in the event that droop is necessary in a design utilizing the ISL6526 or ISL6527. Figure 8 shows a schematic of the power stage and Type III compensation network of an ISL6526/27 regulator with droop.

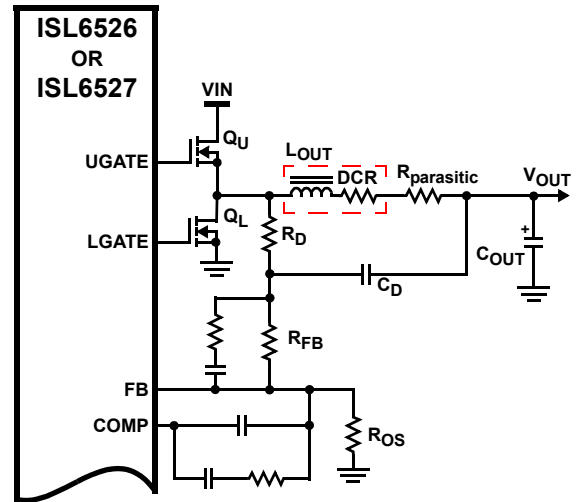

FIGURE 8. DROOP IMPLEMENTATION

circuitry is represented by resistor R_D and capacitor C_D . The output of this low pass filter is fed directly into the feedback compensation network of the regulator. To insure symmetric output voltage excursions about the nominal voltage in response to load transients, the output voltage should be programmed to be above the nominal level by half the calculated droop.

A properly designed droop implementation will have the time constant of the RC filter equal to or very close to the time constant of the output inductor.

$$\tau = \frac{L_{out}}{DCR + R_{parasitic}} = (R_D \parallel R_{FB}) \cdot C_D$$

Note that the impedance portion of the time constant calculation for the RC filter includes the parallel combination of the filter resistor, R_D , and the feedback resistor, R_{FB} . Since the regulation point is now located at the phase node, and a resistor, R_D , is being added to the DC path for regulation, then the offset resistor, R_{OS} , must be adjusted.

$$R_{OS} = \left(\frac{V_{REF}}{V_{NOMINAL} + \frac{1}{2} \cdot I_{O(max)} \cdot DCR - V_{REF}} \right) \cdot (R_{FB} + R_D)$$

Where: $V_{REF} = 0.8V$ for ISL6526
 $V_{REF} =$ External Reference for ISL6527

Figure 9 shows the output voltage of the converter with the droop circuitry added.

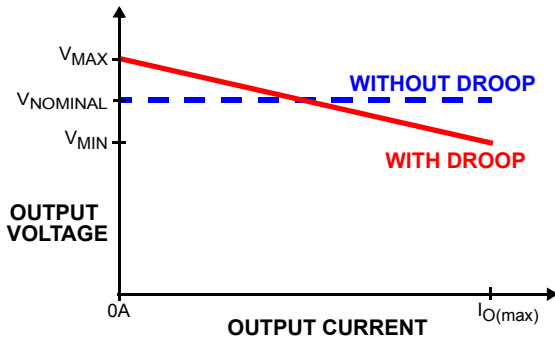

FIGURE 9. OUTPUT VOLTAGE DROOP

With the proper selection of the components used in the RC filter across the inductor, the frequency response of the system is only minimally affected and the compensation network does not need to be recalculated.

Efficiency

The ISL6526 and ISL6527 regulators allow for highly efficient systems. The efficiency of the evaluation board is shown in Figure 10. The efficiencies of the converter for both sinking and sourcing current are identical.

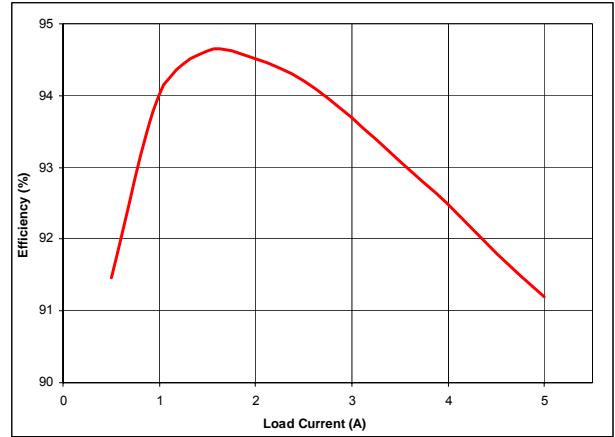

FIGURE 10. EFFICIENCY - SINKING AND SOURCING CURRENT

Conclusion

The ISL6526 and ISL6527 are versatile PWM controllers. Compact and highly efficient regulators can be implemented with either IC. Both ICs offer small footprints and features which make them an ideal for many low voltage power solutions.

References

For Intersil documents available on the web, see <http://www.intersil.com/>

[1] *ISL6526 Data Sheet*, Intersil Corporation, File No. FN9055

[2] *ISL6527 Data Sheet*, Intersil Corporation, File No. FN9056

Evaluation Board Schematic

NOTE: All evaluation boards share the same schematic.

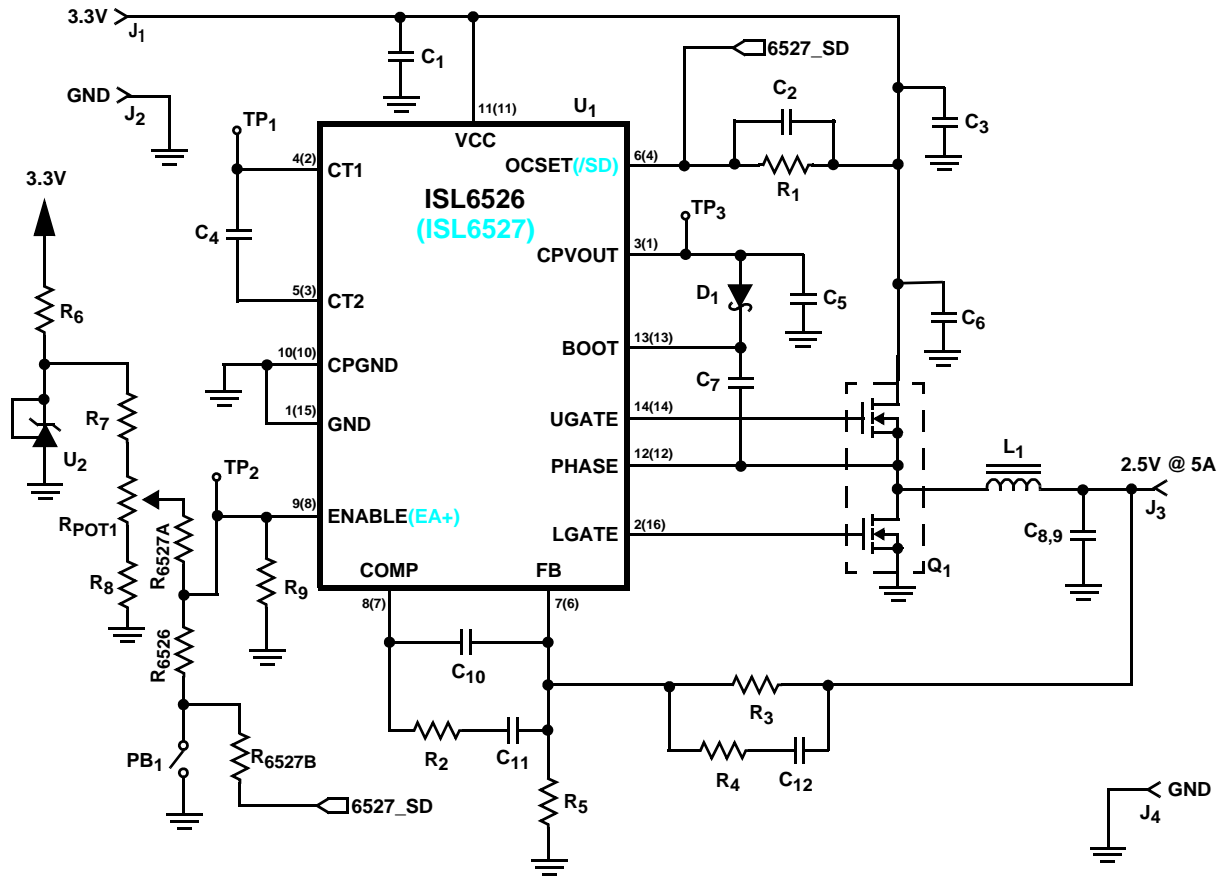

Pin numbers are designated as follows: The first number is the SOIC pin number.
The preceding number in parentheses is the MLFP pin number.

Table 2 - Evaluation Board Specific Bill of Material

| Ref Des | Description | Vendor | Vendor P/N | QTY |
|----------------------------------------------------------------------------------------|--------------------------------------------------------|----------|------------|-----|
| ISL6526EVAL1 Evaluation Board | | | | |
| U1 | ISL6526 300kHz Synchronous Buck PWM Controller - SOIC | Intersil | ISL6526CB | 1 |
| R6526 | Zero Ohm Jumper | Various | --- | 1 |
| R6527A,R6527B | Unpopulated Zero Ohm Jumper | Various | --- | 0 |
| --- | ISL6526A 600kHz Synchronous Buck PWM Controller - SOIC | Intersil | ISL6526ACB | 1 |
| The additional IC is bagged and tagged and shipped with the assembled evaluation board | | | | |
| ISL6526EVAL2 Evaluation Board | | | | |
| U1 | ISL6526 300kHz Synchronous Buck PWM Controller - MLFP | Intersil | ISL6526CR | 1 |
| R6526 | Zero Ohm Jumper | Various | --- | 1 |
| R6527A,R6527B | Unpopulated Zero Ohm Jumper | Various | --- | 0 |
| ISL6527EVAL1 Evaluation Board | | | | |
| U1 | ISL6527 300kHz Synchronous Buck PWM Controller - SOIC | Intersil | ISL6527CB | 1 |
| R6526 | Unpopulated Zero Ohm Jumper | Various | --- | 0 |
| R6527A,R6527B | Unpopulated Zero Ohm Jumper | Various | --- | 2 |
| --- | ISL6527A 600kHz Synchronous Buck PWM Controller - SOIC | Intersil | ISL6527ACB | 1 |
| The additional IC is bagged and tagged and shipped with the assembled evaluation board | | | | |

AN1021

Table 2 - Evaluation Board Specific Bill of Material (Continued)

| Ref Des | Description | Vendor | Vendor P/N | QTY |
|--------------------------------------|--------------------------------------------------------|----------|------------|-----|
| ISL6527EVAL2 Evaluation Board | | | | |
| U1 | ISL6527A 600kHz Synchronous Buck PWM Controller - MLFP | Intersil | ISL6527ACR | 1 |
| R6526 | Unpopulated Zero Ohm Jumper | Various | --- | 0 |
| R6527A,R6527B | Zero Ohm Jumper | Various | --- | 2 |
| | | | | |

Table 3 - Evaluation Board Common Bill of Material

| Ref Des | Description | Vendor | Vendor P/N | QTY |
|-------------|--------------------------------------------------|-----------|---------------|-----|
| C1,C7 | 0.1 μ F Capacitor, 0603 | Various | --- | 2 |
| C2 | 1000pF Capacitor, 0603 | Various | --- | 1 |
| C3,C8,C9 | 150 μ F Capacitor | Panasonic | EEF-UE0J151R | 3 |
| C4 | 0.22 μ F Capacitor, 0805 | Various | --- | 1 |
| C5 | 10 μ F Capacitor | Various | --- | 1 |
| C6 | 1 μ F Capacitor, 0805 | Various | --- | 1 |
| C10 | 33pF Capacitor, 0603 | Various | --- | 1 |
| C11 | 5600pF Capacitor, 0603 | Various | --- | 1 |
| C12 | 8200pF Capacitor, 0603 | Various | --- | 1 |
| D1 | Diode, 30mA, 30V | Digikey | MA732 | 1 |
| L1 | 1 μ H Inductor | Panasonic | ETQP6F1R0SFA | 1 |
| Q1 | Dual MOSFET, 8 Pin SOIC | Fairchild | ITF86110DK8 | 1 |
| R1 | 9.76k Ω 1% Resistor, 0603 | Various | --- | 1 |
| R2 | 6.49k Ω 1% Resistor, 0603 | Various | --- | 1 |
| R3 | 2.26k Ω 1% Resistor, 0603 | Various | --- | 1 |
| R4 | 124 Ω 1% Resistor, 0603 | Various | --- | 1 |
| R5 | 1.07k Ω 1% Resistor, 0603 | Various | --- | 1 |
| R6 | 1.33k Ω 1% Resistor, 0603 | Various | --- | 1 |
| R7 | 61.9k Ω 1% Resistor, 0603 | Various | --- | 1 |
| R8 | 13.3k Ω 1% Resistor, 0603 | Various | --- | 1 |
| R9 | 100k Ω 1% Resistor, 0603 | Various | --- | 1 |
| RPOT1 | 25 Turn Potentiometer 0 Ω to 50k Ω | Digikey | 3299Y-503-ND | 1 |
| PB1 | Pushbutton, miniature | Digikey | P8007S-ND | 1 |
| U2 | Adjustable Precision Zener Shunt Regulator | National | LM431CCM3/N1B | 1 |
| TP1,TP2,TP3 | Test Points | Digikey | 5002K-ND | 3 |
| J1,2,3,4 | Test Points | Keystone | 1514-2 | 4 |

Board Description - MLFP

Silk Screen

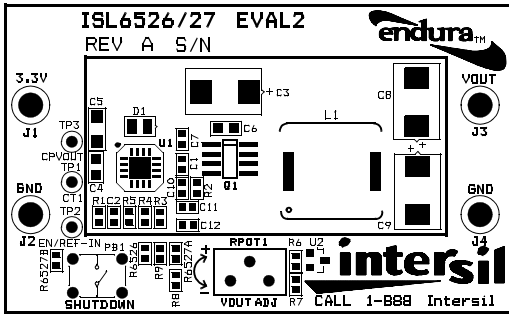

Top Layer

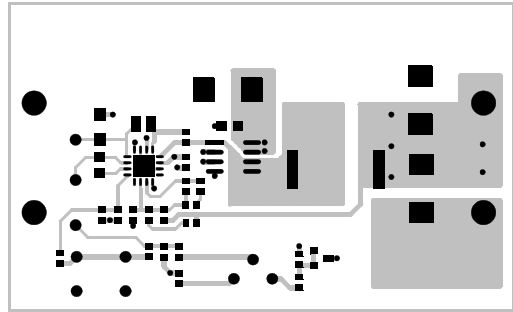

Ground Layer

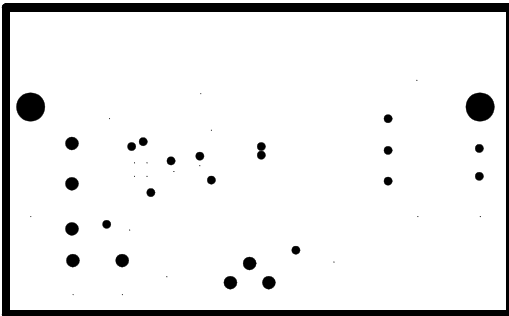

Power Layer

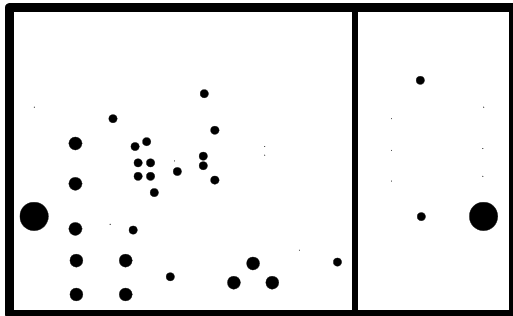

Bottom Layer

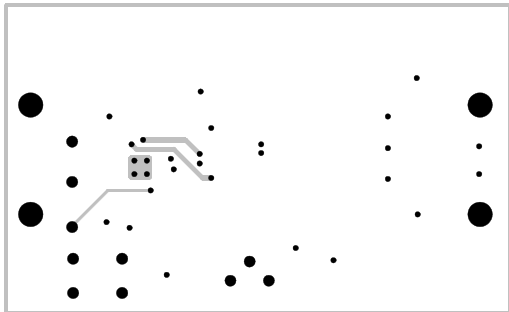

Board Description - SOIC

Silk Screen

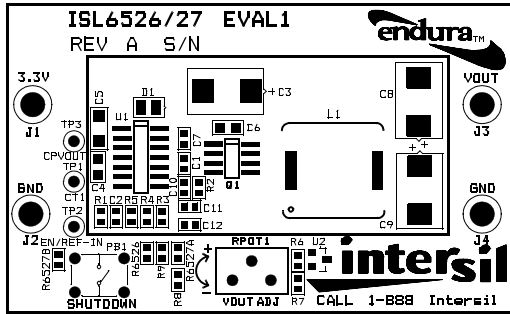

Top Layer

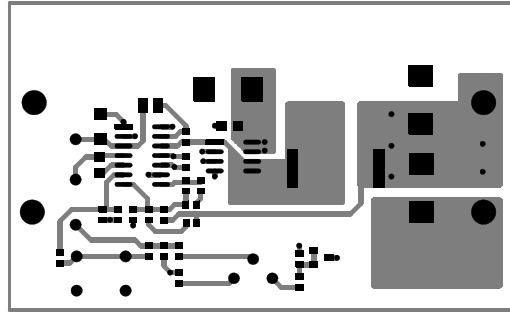

Ground Layer

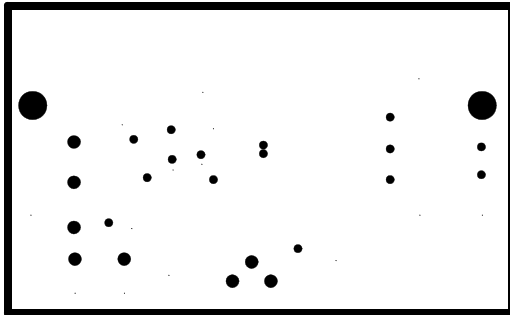

Power Layer

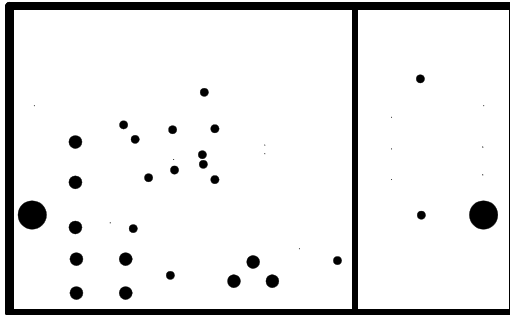

Bottom Layer

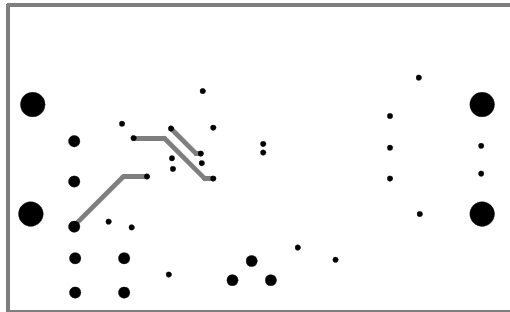

All Intersil U.S. products are manufactured, assembled and tested utilizing ISO9000 quality systems. Intersil Corporation's quality certifications can be viewed at www.intersil.com/design/quality

Intersil products are sold by description only. Intersil Corporation reserves the right to make changes in circuit design, software and/or specifications at any time without notice. Accordingly, the reader is cautioned to verify that data sheets are current before placing orders. Information furnished by Intersil is believed to be accurate and reliable. However, no responsibility is assumed by Intersil or its subsidiaries for its use; nor for any infringements of patents or other rights of third parties which may result from its use. No license is granted by implication or otherwise under any patent or patent rights of Intersil or its subsidiaries.

For information regarding Intersil Corporation and its products, see www.intersil.com